

Product Catalogue
10/2023

PVC-U windows

activPilot Topstar

Fully-concealed turn-tilt fittings for design windows.

NEW



1 Complementary range activPilot Topstar

This catalogue is to provide detailed information on the activPilot Topstar product range.

The activPilot Topstar turn-tilt fitting range is a complement to our extensive activPilot portfolio. You can find the standard activPilot components in our activPilot Concept product catalogue. If you don't have it on hand, request our catalogue. We remain at your disposal for further questions.

The processing details regarding burglary-resistant window units can be gathered from the DIN EN 1627 - 1630 system documentation. The lists of fittings in this catalogue are merely intended to give application examples. Get in touch with your Winkhaus contact partner for more details.



New hinge side for activPilot Topstar

What has changed ?

- Increase of the lateral adjustment in the lower hinge area to ± 2.5 mm.
- Increased service life according to DIN 13126-8 H3 to 20,000 switching cycles (when sash hinge rail is used *).
- Increase of the max. permissible sash weight to 150 kg (with use of sash hinge rail *).

* Observe areas of application!

Which components are new?

- Corner hinge EL...IF-N
- Sash hinge FL.IF-N
- Shear S...IF-N
- Turn hinge DL...IF-N



Please note! Fitting parts of the old hinge side must not be mixed with the new-generation fitting parts!

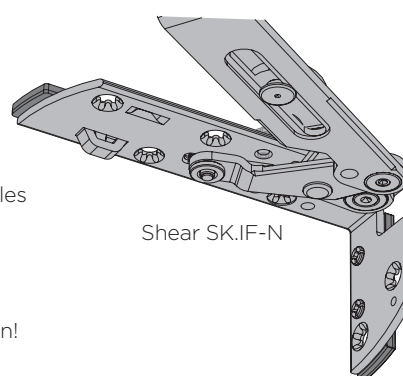

Shear SK.IF-N

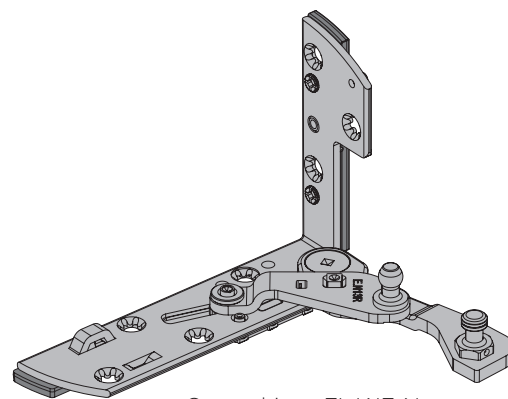

Corner hinge EL.K.IF-N

The following information and illustrations reflect the current state of our development and manufacturing of this product. In order to achieve customer satisfaction and reliability of the hardware components we reserve the right to change the product. Any information given in this document has been compiled and verified with the greatest care. Some of the indicated dimensions are rounded measures! Due to the constant technical progress, changes in legislation and other inevitable changes, we cannot accept any responsibility for the accuracy and completeness of the contents. We are always thankful for suggestions and comments. Taking into account the information and facts given here with regard to windows (and doors), the fitting system can easily be installed.

Copyright:

© Aug. Winkhaus GmbH & Co. KG, all rights and modifications are reserved.

		Page	
1	General product information	2-27	1
2	Lists of Fittings	28-61	2
3	Drive rods		3
4	Corner drives	62	4
5	Top rods	63-64	5
6	Sash hinges/Corner hinges	65-67	6
7	Shears/Shear hinges	68	7
8	Turn hinges/Tilt hinges	69-71	8
9	Extension rods		9
10	Accessories	72-75	10
11	Frame parts	76-82	11
12	Mounting accessories		12
13	Installation Instructions	83-110	13
14	Adjustment/maintenance	111-115	14
15	Installation drawings	116-117	15

1

activPilot Topstar

For PVC-U windows with high aesthetic demands

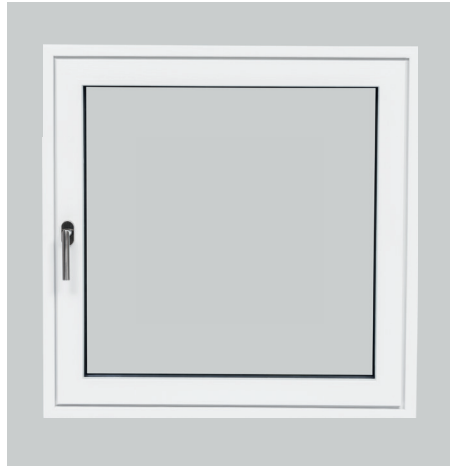

Technical features

- Easy and quick assembly thanks to profile adjustment
- Suitable for sash weights of up to 130 kg without requiring additional parts for load transfer
- For internally flush or offset PVC-U profiles
- Suitable for narrow frames with small free sizes of the frame

Advantages of the fitting system

- + Easy to combine with the modular activPilot system
- + Compatible with top rails from the activPilot Select product segment
- + Simple three-dimensional adjustment
- + Convenient installation – simply lower the sash on the hinge brackets in a slightly tilted position
- + Energy efficiency – sealing plane is not interrupted
- + Opening angle approx. 95°

Flexible and versatile applications

Special requirements? Can be met with Winkhaus activPilot Topstar.

Dimensions for:

- Minimum gap dimension for flush windows
- Minimum free size from the outer edge of the sash to the reveal

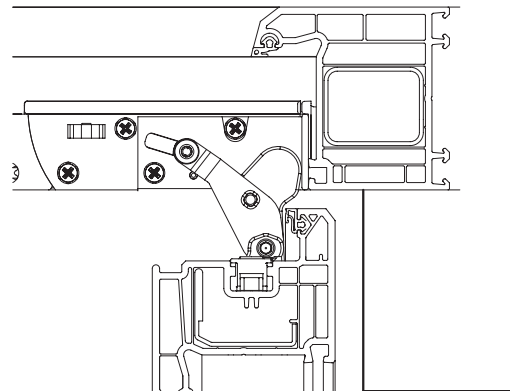
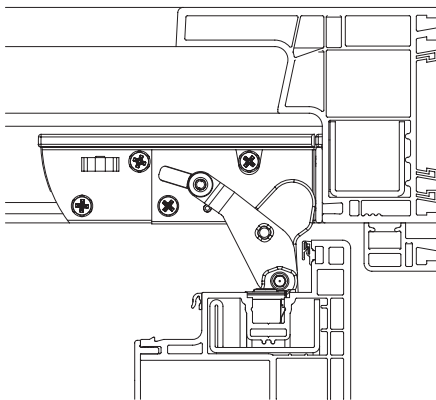
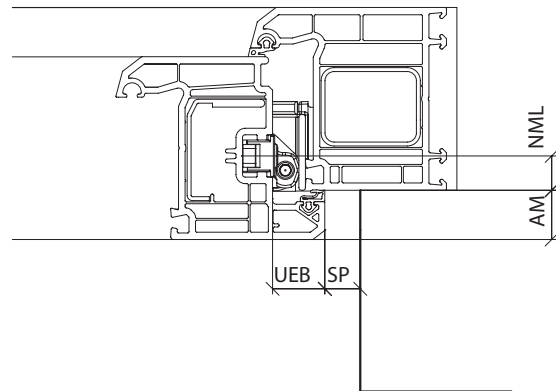
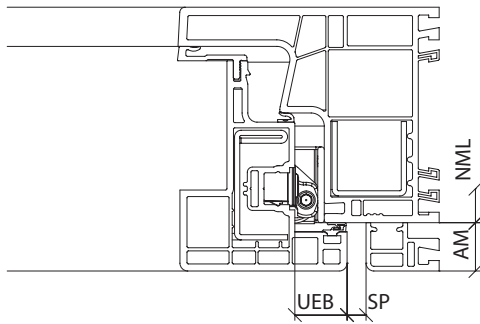

AM	UEB	SP 13 mm NML
18	20	7
20	20	9
22	20	11
24	20	13

AM = overlap dimension

UEB = overlap

NML = groove centre position

SP = Min. gap dimension

The gap dimensions also depend on the shape and radiuses of the overlap.

activPilot Topstar

As a leading manufacturer of fully-concealed fitting solutions Winkhaus is always keen to develop its products consistently and to adapt them to the changing requirements of the customers. The result of this process is activPilot Topstar. activPilot Topstar unites the advantages of energy efficiency and load capacity of large and heavy windows which are required to offer superior design without visible hinges. activPilot Topstar seamlessly integrates with the existing fully-concealed fitting solutions activPilot Elegance and activPilot Select adding further solution possibilities in the field of design windows. Thanks to the activPilot Topstar's movement kinematics directed inwardly, it is possible to manufacture flush windows with narrow shadow joints from 4 mm. In offset profiles it is possible to achieve a free size of the frame from 4 mm to the wall reveal. For the production of activPilot Topstar fittings we use high-tensile steel in order to enable the sashes weighing up to 130 kg to be securely operated in spite of the compact design. In addition, highly-hardened stainless steel keeps help to reduce wear and tear on sensitive friction surfaces improving the endurance of hinge components. When developing the activPilot Topstar fitting system we attached much importance not only to the technical features, but also to the assembly friendliness and the easy accessibility of the adjustment screws. When the sash is lowered in the tilt position onto the corner hinge, the bearing points are located as if by themselves. This prevents the hinges from being subjected to adverse loads from the outset.

Modular design

activPilot optimises window construction. For the window builder, less components and multifunctionality mean uncomplicated and fast processing and rational mounting. Pre-mounted components and the unique design additionally ensure that additional functions and safety classes can be achieved easily by retrofitting. activPilot thus sets the scene for sustainably cutting your production, warehousing, logistics and administration costs.

The locking system with octagonal locking bolts

activPilot enhances comfort. The functionally perfect locking mechanism not only guarantees precise entry of the locking bolt into the frame keep, but also a perfect seal. This is ensured by the increased air gap tolerance and the new octagonal locking bolt which allows easy adjustment of the contact pressure. Even adjusting forces and the non-positive and positive system fit of the components give this fitting the required stability and long-term functionality.

Add-on functions

activPilot gives you the ability to react flexibly to customer requests. Innovative multi-purpose components make it easy to retrofit features at any time. The use of a duo and/or tri functional element makes it simple to add a fail safe device with integrated limiter support and balcony door catch. The variable tilt device supports different sash tilt angles and thus fast, easily adjustable ventilation settings.

Design

activPilot offers you and your customers real added value. Surprising details, discreet accents, ergonomic design and comprehensive functions characterise the overall concept of the fitting system. In short its attractive design will be a crucial factor when it comes to your customers making a purchase decision. activPilot also offers other convincing arguments such as outstanding durability, easy-to-clean surfaces, intuitive operation and, last but not least, aesthetically pleasing windows.

Surface

activPilot fittings feature a surface refinement finish based on nanotechnology, which is applied in our in-house plating shop. This surface stands out due to its very high resistance to all environmental influences. This is verified by quality controls consisting of alternate climate and salt spray testing according to DIN EN ISO 9227 and is certified by tests on a regular basis. Winkhaus also carries out tests in outside areas, thus testing component behaviour under realistic conditions. This enables Winkhaus to offer a ten-year warranty for functions and surfaces.

Effective security

Thanks to this unique modular system, any window can be modified to achieve the required security standard - easily, quickly and cost-efficiently. There is no need for custom parts. Depending on the number and type of keeps, various security levels are achievable using the same platform. At our works, comprehensive and strict tests - along with ongoing functional monitoring - ensure maximum security for customers. Approval marks and certificates by independent test authorities confirm our results. You can therefore rely on activPilot meeting customer requirements for a secure fitting system. Locking bolts are made of high-strength steel; even standard types guarantee effective basic security. Depending on the number and type of keeps, the fitting system can be enhanced for compliance with stricter security classes - including burglar protection to DIN V ENV 1627-1630, RC2.

Quality standard

The Winkhaus group successfully passed a group certification of production sites according to DIN EN ISO 9001:2015 / DIN EN ISO 50001:2011. The group certification ensures that we use the same criteria and procedures in all Winkhaus subsidiaries and thus we can always offer consistent quality for our customers.



We successfully passed the demanding QM 328 certification.

activPilot fittings from Winkhaus are certified in accordance with QM 328. The turn-only and turn-tilt fittings for windows and patio doors undergo a large number of tests in this stringent certification programme, which verifies aspects such as durability and quality control mechanisms. The certificate stands as a testament to Winkhaus' long tradition in high quality products.

Endurance test

Winkhaus activPilot is certified in accordance with EN 13126-8 (endurance test for turn-only and turn-tilt fittings) and EN 1191 (endurance test for windows and doors). The fitting thus complies with EN standards. Winkhaus' own permanent control in accordance with established production control guidelines as well as regular external monitoring by ift Rosenheim ensure outstanding product quality guaranteed on a long-term basis.

Your partner for service

Our services are solution-orientated, reliable and precisely geared to match your requirements - just as you would expect from your partner. We are at your disposal whenever you need us. With application engineers on site, professional help from our product data service and innovative software solutions to help optimise your workflows, we ensure you are able to work as you require and also broaden your professional service capabilities. What's more, our comprehensive product information system and sophisticated logistics guarantee fast delivery any time you need it.

Proper screw fixing in terms of load of security-relevant fitting components

In order to ensure the endurance and operating safety of windows and balcony doors over their expected service life, major importance must be attached to the installation of security-relevant fitting components! Manufacturers of windows and balcony doors are responsible for fixing the fitting elements on the sash and the frame in a professional way and they must make sure that the specifications are adhered to. Important: Follow these guidelines! Always use screws that are long enough to bear the loads.

Basic technical features of the activPilot fitting system

In the following section you will find the general features that apply to all activPilot fitting components in the sash area, unless otherwise described on the corresponding product pages.

- Face plate width of sash fitting parts: 16 mm
- Overlapping system linkage without connecting plates
- Delivery state of sash fitting parts: centre fixed in turn position
- Safety locking pin as an adjustable octagonal bolt
- Sash fitting parts can be used right/left, unless otherwise stated.

Zertifikat / Certificate



Zertifikatsnr. / Certificate No.: 228-7019950-1-17

Dreh- und Drehkippsbeschläge für Fenster und Fenstertüren Turn and tilt-turn hardware for windows and casement doors

Produkt
product **activPilot, proPilot**

max. Flügelgewicht
max. casement weight **max 200 kg**

Einsatzbereich
field of application **Systeme mit entsprechender Beschlagaufnahme**
Systems with suitable hardware groove

Hersteller
manufacturer **Aug. Winkhaus GmbH & Co. KG**
August-Winkhaus-Str. 31, D 48291 Telgte



Produktionsstandort
production site **Aug. Winkhaus GmbH & Co. KG**
August-Winkhaus-Str. 31, D 48291 Telgte

Mit diesem Zertifikat wird bescheinigt, dass das benannte Bauprodukt den Anforderungen des zugrundeliegenden ift-Zertifizierungsprogramms in der aktuellen Fassung entspricht.

This certificate attests that the building product mentioned fulfills the requirements of the underlying ift-certification scheme in its current version.

- Erstellung von Produktfamilien des aufgeführten Bauproduktes und Erstprüfung durch eine akkreditierte Prüfstelle nach EN 13126-8:2017 unter Berücksichtigung der Anwendungsdiagramme
- Einführung und Aufrechterhaltung einer werkseigenen Produktionskontrolle durch den Hersteller
- Erstinspektion des Werkes und der werkseigenen Produktionskontrolle durch ift-Q-Zert
- kontinuierliche Fremdüberwachung des Werkes und der werkseigenen Produktionskontrolle durch ift-Q-Zert

- compilation of product families of the building product listed and initial type-testing by an accredited testing body as per EN 13126:8:2017 based on the application diagrams
- implementation and maintenance of a factory production control by the manufacturer
- initial inspection of the production site and the factory production control by ift-Q-Zert
- continuous third-party control of the production site and the factory production control by ift-Q-Zert

Dieses Zertifikat wurde erstmals am 18. November 2008 ausgestellt und gilt 5 Jahre, wenn sich zwischenzeitlich die Festlegungen in der oben angeführten technischen Spezifikation oder die Herstellbedingungen im Werk oder in der werkseigenen Produktionskontrolle selbst nicht wesentlich verändert haben.

This certificate was first issued on 18. November 2008 and will remain valid for 5 years, as long as neither the conditions laid down in the technical specification listed above nor the manufacturing conditions in the production site nor the factory production control itself are modified significantly.

Das Zertifikat darf nur unverändert vervielfältigt werden. Alle Änderungen der Voraussetzungen für die Zertifizierung sind dem ift-Q-Zert mit den erforderlichen Nachweisen unverzüglich schriftlich anzuzeigen.

The reproduction of the certificate without any change from the original is permitted. Any changes to the prerequisites applicable to certification shall be immediately communicated in writing to ift-Q-Zert accompanied by the necessary evidence.

Das Unternehmen ist berechtigt, das benannte Bauprodukt gemäß der ift-Zeichensatzung mit dem „ift-zertifiziert“-Zeichen zu kennzeichnen.

The company is authorized to affix the "ift-certified"-mark to the building product mentioned according to the ift-rules for use of the "ift-certified"-mark.

Dieses Zertifikat enthält 2 Anlage/n.

This certificate contains 2 annexes.

ift Rosenheim
25. März 2019

Christian Kehrer
Leiter der ift-Zertifizierungs- und Überwachungsstelle
Head of ift Certification and Surveillance



Prof. Ulrich Sieberath
Institutsleiter
Director of Institute

228 7019950

Gültig bis /
Valid until:

10. Oktober 2023

2018-01 / 797

Grundlage(n) /
Basis:

ift-Zertifizierungsprogramm für Beschläge
ift-certification scheme for hardware (QM 328)
Ausgabe/issue 2018

EN 1191
EN 12400
bis Klasse 3
up to class 3



Dauerfunktion
resistance to repeated opening and closing

EN ISO 9227

EN 1670

bis Klasse 5
up to class 5



Korrosionsschutz
corrosion protection



www.ift-rosenheim.de

ift Rosenheim GmbH
Theodor-Gietl-Str. 7-9
D-83026 Rosenheim

Kontakt
Tel.: +49 8031 261-0
Fax: +49 8031 261-290
www.ift-rosenheim.de

Prüfung und Kalibrierung – EN ISO/IEC 17025
Inspektion – EN ISO/IEC 17020
Zertifizierung Produkte – EN ISO/IEC 17085
Zertifizierung Managementsysteme – EN ISO/IEC 17021

Notified Body 0757
PUZ-Stelle: BAY 18

DAKKS
Deutsche
Akkreditierungsstelle
D-ZE-11349-01-00

Anlage / annex 1
 Hersteller / manufacturer:
 Aug. Winkhaus GmbH & Co. KG
 Ausgabedatum / date of issue: 25. März 2019



Zertifikatsnr. / Certificate No.: 228-7019950-1-17

In der Zertifizierung enthaltene Produktfamilien für Fenster- und Fenstertürsysteme mit geeigneter Beschlagsaufnahme.

Product families for window and casement door systems with groove designed for accommodation of hardware, covered by certification.

lfd. Nr./ no.	Ausführung Bandscheitel/ type hinge side	Ausführung Flügelbeschlag/ type casement hardware	Beschreibung der Ausführung der blendrahmenseitigen Beschlagsausführung detail description of frame member hardware type				Klassifizierung nach EN 13126-8:2017 classification as per EN 13126-8:2017			
			Winkelband/ top stay connecting part	Scherenlager/ stay arm support	Eckband/ corner hinge	Ecklager/ corner pivot	1	2	3	4
							Dauerfunktionsfähigkeit/ durability	Masse (in kg)/ mass	Korrosionsbeständigkeit/ corrosion resistance	Prüfgrößen (in mm)/ test sizes
1	activPilot K 100	activPilot K 100	SK2.20-13	SL.KS.3-6	FL.K. 20-6-20	EL.K. 6-3-16	H2	100	5	1300 mm x 1200 mm
2	activPilot K 100	activPilot K 100	SK2.20-13	SL.KS.3-6	FL.K. 20-6-20	EL.K. 6-3-16	H2	100	5	900 mm x 2300 mm
3	activPilot K 130 S	activPilot K 130 S	SK2.20-13	SL.K.3-6.130	FL.K. 20-6-28.130	ESV 6-3-16	H3	100	5	1300 mm x 1200 mm
4	activPilot Comfort PADK 100	activPilot Comfort PADK 100	SK2.PA.20-13	SL.KS.3-6	FL.E.FWPA 20-13	ESV 6-3-16	H2	100	5	1300 mm x 1200 mm
5	activPilot Comfort PADK 100	activPilot Comfort PADK 100	SK2.PA.20-13	SL.KS.3-6	FL.E.FWPA 20-13	ESV 6-3-16	H2	100	5	900 mm x 2300 mm
6	activPilot Comfort PADM 100	activPilot Comfort PADM 100	SK2.PAD. 20-13	SL.KS.3-6	FL.E.FPAD 20-13	ESV 6-3-16	H2	100	5	1300 mm x 1200 mm
7	activPilot Comfort PADM 100	activPilot Comfort PADM 100	SK2.PAD. 20-13	SL.KS.3-6	FL.E.FPAD 20-13	ESV 6-3-16	H2	100	5	900 mm x 2300 mm
8	activPilot C 130	activPilot C 130	SC2.20-13	SL.C.3-6	FL.C.W. 20-13	EL.CS. 6-3-22	H3	130	5	1400 mm x 1550 mm
9	activPilot K 130	activPilot K 130	SK2.20-13	SL.KB.3-6	FWW 20-13	ESVW 6-3-16	H2	130	5	1300 mm x 1200 mm

Anlage / annex 1
 Hersteller / manufacturer:
 Aug. Winkhaus GmbH & Co. KG
 Ausgabedatum / date of issue: 25. März 2019



Zertifikatsnr. / Certificate No.: 228-7019950-1-17

10	activPilot K 130	activPilot K 130	SK2.20-13	SL.KB.3-6	FWW 20-13	ESVW 6-3-16	H2	130	5	900 mm x 2300 mm
11	activPilot ALU 130	activPilot ALU 130	SK2.20-13	SL.KB.3-6	FWV 20-13	ESVW 6-3-16	H2	130	5	1300 mm x 1200 mm
12	activPilot ALU 130	activPilot ALU 130	SK2.20-13	SL.KB.3-6	FWW 20-13	ESVW 6-3-16	H2	130	5	900 mm x 2300 mm
13	activPilot K 130 S	activPilot K 130 S	SK2.20-13	SL.K.3-6.130	FL.K. 20-6-28.130	ESV 6-3-16	H2	130	5	1300 mm x 1200 mm
14	activPilot K 130 S	activPilot K 130 S	SK2.20-13	SL.K.3-6.130	FL.K. 20-6-28.130	ESV 6-3-16	H2	130	5	900 mm x 2300 mm
15	activPilot H 130	activPilot H 130	SH2.T. 18-13-12	SL.HT.18-12	FL.HT. 18-13-12	EL.HT.Z. 18-12	H3	130	5	1300 mm x 1200 mm
16	activPilot H 150	activPilot H 150	SH2.T. 18-13-12	SL.HT.18-12	FL.HT. 18-13-12	EL.HT.Z. 18-12	H3	150	5	900 mm x 2300 mm
17	activPilot Giant	activPilot Giant	SXL.20-13	SL.XL	FL.XL	EL.XL	H3	200	5	1550 mm x 1400 mm
18	activPilot Giant	activPilot Giant	SXL.20-13	SL.XL	FL.XL	EL.XL	H2	200	5	900 mm x 2300 mm
19	activPilot Select K 100	activPilot Select K 100	SK.SE	ohne without	FL.SE	EL.K.SE	H2	100	5	1300 mm x 1200 mm
20	activPilot Select H 130	activPilot Select H 130	SH.SE. 20-9.Z.	ohne without	FL.SE	EL.H.SE. 20-9.Z. mit/with FLS.SE	H2	130	5	1300 mm x 1200 mm
21	activPilot Topstar	activPilot Topstar	SH.IF.24-13	ohne without	FL.IF	EL.H.IF. 24-13	H2	130	5	1300 mm x 1200 mm

Anlage / annex 1
 Hersteller / manufacturer:
 Ausgabedatum / date of issue:

Seite / page 3 von / of 3
 Aug. Winkhaus GmbH & Co. KG
 25. März 2019



Zertifikatsnr. / Certificate No.: 228-7019950-1-17

22	activPilot Topstar	activPilot Topstar	SH.IF.24-13	ohne without	FL.IF	EL.H.IF.24-13	H2	130	5	900 mm x 2300 mm
23	activPilot Select K 150	activPilot Select K 150	SK.SE	ohne without	FL.SE	EL.K.SE mit/with FLS.SE	H2	150	5	1550 mm x 1400 mm
24	activPilot Select K 150	activPilot Select K 150	SK.SE	ohne without	FL.SE	EL.K.SE mit/with FLS.SE	H2	150	5	900 mm x 2300 mm
25	activPilot Select ALU 150	activPilot Select ALU 150	SK.SE	ohne without	FL.SE	EL.K.SE mit/with FLS.SE	H2	150	5	1550 mm x 1400 mm
26	activPilot Select H 150	activPilot Select H 150	SH.SE.29-13	ohne without	FL.SE	EL.H.SE.29-13 mit/with FLS.SE	H2	150	5	1550 mm x 1400 mm
27	proPilot	proPilot	SK.U.2.20-13	SL.K.U.3-3	FL.K.U.6	EL.K.U.3-3	H2	70	4	1300 mm x 1200 mm
28	proPilot	proPilot	SK.U.2.20-13	SL.K.U.3-3	FL.K.U.6.100	EL.K.U.3-3	H2	100	4	1300 mm x 1200 mm
29	activPilot C 150	activPilot C 150	SC2.20-13	SL.C.3-6	FL.C-W-20-13	EL.CS.6-3-22	H3	150	5	900 mm x 2300 mm
30	activPilot C 150	activPilot C 150	SC2.20-13	SL.C.3-6	FL.C.20-6-28	EL.C.6-3-22	H3	150	5	900 mm x 2300 mm
31	activPilot C 130	activPilot C 130	SC2.20-13	SL.C.3-6	FL.C.20-6-28	EL.C.6-3-22	H3	130	5	1400 mm 1550 mm

Die Ergebnisse sind auf folgende Ausführungsvarianten übertragbar: Beschlagsausführung links/rechts, alle zulässigen Größen gemäß Anwendungsdiagramm sowie andere Falz- und Profillegeometrien. Die technische Dokumentation des Beschlagherstellers, insbesondere die entsprechenden Anwendungsdiagramme, ist zu beachten.
 The results can be applied to the following design variants: hardware type left/right, all permissible sizes in accordance with the application diagram as well as other rebate and profile geometries. Observe technical documents of hardware manufacturer, in particular the relevant diagrams.

Obligations to provide information and instructions

This document brings together important information and details regarding different fittings and their further processing. The information is particularly intended for window and balcony door manufacturers and fitting and structural component retailers. Accidents and physical damage can be avoided if you observe the information contained in this information. For this reason, you must always ensure that you pass on the relevant documents when you hand fittings over to somebody else. Information and documents should be handed over in printed format, on a CD ROM or online, for example.

Guidelines for the use of locking systems and fittings

Gütegemeinschaft Schlösser und Beschläge e.V., Velbert issues guidelines offering assistance for the use of locking systems and fittings for windows, doors and patio doors. These guidelines are established in cooperation with the trade association of the locks and fittings industry in Velbert as well as the testing institute PIV which is also based in Velbert. If required, they are agreed with the VFF technical committee and ift Rosenheim. As a result the experience and test findings of several decades are considered. The guidelines provide information about the intended use and maintenance of fittings for windows and patio doors. It is mandatory to observe these guidelines. The current guidelines can be accessed in different languages at the following Internet address: <http://www.beschlagindustrie.de/ggsb/richtlinien.asp>



As an alternative to using the www address, you can also scan the QR Code with your smartphone!

Follow this link to find the applicable and binding guidelines on the following topics:

- VHBH - Fittings for windows and patio doors [with guidelines / instructions on the product and liability]
- VHBE - Fittings for windows and patio doors [with guidelines / instructions for end users]
- TBDK - Attachment of supporting fitting components of turn and turn-tilt fittings [with definitions of turn and turn-tilt fittings as well as their possible mounting positions]
- FPKF - Safety and cleaning shears for tilt sashes and tilt-ing fanlights [use of safety and cleaning shears]
- FPDF - Sash limiters for variable turn position of sashes [sash limiters controlled by central locking system – definitions and tests]



The VHBH guideline among others contains the chapter “Obligation to give instructions”. A schematic illustration shows the documents and information to be submitted to the different target groups for respecting the instructions obligation. The building owner must pass on the documents defined in the chapter “Obligation to give instructions” to the end user.



Gütegemeinschaft Schlösser und Beschläge e.V.

Richtlinie: TBDK

ORIGINALFASSUNG Ausgabe: 2014-05-05

Richtlinie

Befestigung tragender Beschlagteile von Dreh- und Drehklipp-Beschlägen mit Definitionen zu Dreh- und Drehklipp-Beschlägen sowie deren möglichen Einbautagen

Inhalt:

1	Vorwort	3
2	Anwendungsbereich	3
3	Begriffe	6
4	Deutsprachfähigkeit – Grenzen der Richtlinie	7
5	Empfehlungen für die Befestigung	8
6	Durchführung der Prüfungen	8
7	Vorgaben zu den Kräften	15
8	Literaturhinweis	22

Herausgeber:

Gütegemeinschaft Schlösser und Beschläge e.V.
 Offerstraße 12
 42551 Velbert

Phone: +49 (0)2051 / 95 06 - 0
 Fax: +49 (0)2051 / 95 06 - 20
 www: [www: www.beschlagindustrie.de](http://www.beschlagindustrie.de)
www.beschlagindustrie.de/ggsb/richtlinien.asp

Hinweis

Technische Angaben und Empfehlungen dieser Richtlinie beruhen auf dem Kenntnisstand bei Drucklegung. Es gilt der Inhalt des „Disclaimer“ auf der o.g. Internet-Seite.

Richtlinie TBDK
1 / 23

Product liability guidelines

Turn and turn-tilt fittings for windows and patio doors

According to the current product liability legislation dealing with a manufacturer's liability for his products (§ 4 Prod-HaftG) please observe the following information on turn and turn-tilt fittings for window and patio door sashes. The manufacturer will not accept any liability for noncompliance with these specifications.

1. Product information and intended use

Turn and turn-tilt fittings within the meaning of this definition are single handle turn-tilt fittings for windows and patio doors as used in building applications. They are used to bring window and window sashes into a turn position or into a tilt position limited by the shear version using a hand lever. Turn and turn-tilt fittings are used on vertically installed windows and patio doors made of wood, PVC-U, aluminium or steel and their corresponding material combinations. Conventional turn and turn-tilt fittings in the sense of this definition close/lock window and patio door sashes and bring them into different ventilation positions. As a rule, the counterforce of a seal must be overcome when closing. Uses deviating from this do not correspond to the intended use. Burglary-resistant windows and patio doors, windows and patio doors for damp rooms and those for use in environments with aggressive, corrosion-promoting air contents require fittings with performance characteristics coordinated and separately agreed for the respective application. Opened window and patio door sashes only achieve a shielding function and do not meet any requirements for joint tightness, watertightness, sound insulation, thermal insulation and burglary resistance. In wind and draughts, window and window sashes must be closed and locked. Wind and draught in the sense of this definition are present if the window or patio door sashes in one of the opening positions open or close automatically and uncontrollably due to air pressure or air suction. A fixed open position of window and patio door sashes can only be achieved with arresting additional fittings. The resistance to wind loads in closed and locked state depends on the respective constructions of windows and patio doors. If wind loads must be transferred in accordance with DIN EN 12210 (particularly test pressure p_3), suitable fitting combinations must be agreed in conjunction with the respective window construction and the frame material and agreed separately. In general, the turn and turn-tilt fittings can meet the requirements for barrier-free apartments in accordance with DIN 18025. However, this requires corresponding fitting combinations and assemblies in the windows and patio doors, which must be coordinated and agreed separately.

2. Misuse

Misuse – i.e. the use of a product in a manner contrary to the manufacturer's instructions – of turn-tilt fittings for windows and patio doors occurs

- if obstacles are placed in the opening area preventing the intended use.
- if sashes of windows / patio doors are pushed or hit against the window reveal, either contrary to the manufacturer's instructions or in an uncontrolled way (e.g. by wind), that the fittings, the frame materials or other individual parts of the window sash or the patio door sash are damaged or destroyed or subsequent damage occurs
- if additional loads act on the sashes of windows or patio doors (e. g. children swinging on them).
- if someone grasps in the gap between the frame and sash when closing the window (risk of injury).

3. Liability

The respective overall fitting must be selected from the original Winkhaus activPilot fitting components range. Winkhaus accepts no liability if non-original or unauthorised system accessory parts are used. Important: The screw / clamping connection of load-bearing fitting components, such as corner, shear and sash hinges must be designed according to the TBDK guidelines. Please adapt the fixing procedure of the fitting components to the load situation.

4. Product performance – Manufacturer's instructions for use

The maximum sash weights for the individual fitting versions may not be exceeded. The component with the lowest permissible loading capacity determines the maximum weight of the sash. Please observe the diagrams and component installation instructions.

4.1 Sash sizes and areas of application

The graphs in the application diagrams show the permitted sash rebate height to width ratios, as determined by different weights of glass and/or overall glass thickness. The resulting sash rebate dimensions or sash formats (portrait/ landscape) as well as the maximum sash weight may under no circumstances be exceeded.

4.2 Application diagram for determination of the permissible sash sizes

The application diagrams for this fitting series for the determination of permissible sash sizes are described and explained separately on the following pages.

4.3 Composition of fittings

You must comply with the manufacturer's specifications regarding the configuration of fittings (e.g. the use of additional shears, the layout of fittings for burglary-resistant windows and patio door sashes, etc.).

5. Product maintenance

Security-relevant fitting parts are to be inspected at least once a year to check for wear and to ensure they are firmly secured in position. Fastening screws must be tightened and faulty components must be replaced as required. In addition, maintenance/cleaning work must be carried out at least once a year. All mobile parts and locking points of fittings should be greased and tested for function. Only oils and greases not affecting the materials of the fitting may be used. The only cleaning and maintenance materials to be used are those which will not adversely affect the corrosion-resistant properties of the fitting components.



Adjustment work to the fittings – particularly in the area of the corner drive and the shears – as well as the replacement of parts and mounting and removal of opening sashes must be carried out by a trained specialist.

5.1 Maintaining surface quality

- The fittings and rebate spaces must be adequately ventilated, particularly during the construction stage, so that they are not exposed to the direct effects of moisture or condensation. It must be ensured in any case by appropriate measures that there is no possibility for (permanently) humid room air to condense in the rebate area.
- The fittings must be kept free from deposits and soiling due to building materials (building dust, gypsum plaster, cement etc.). Possible soiling from plaster, mortar etc. must be removed prior to bonding with water.
- Corrosive vapours (e.g. formic acid, acetic acid, ammonia, amine and ammonia compounds, aldehydes, phenols, chlorine, tannic acid etc.) combined with even a small amount of condensation can cause rapid corrosion of the fittings. Therefore, such evaporation in the area of the windows must be avoided at all costs.

- Furthermore no sealants that cure with acetic or other acids, or sealants containing any of the above-mentioned substances, must be used. Both direct contact with the sealant and vapours released from it can damage the surface.
- Only use a mild and pH neutral detergent in diluted form to clean the fittings. Under no circumstances use aggressive acidic cleaners or scouring agents containing the substances listed above.

6. Obligations to provide information and instructions

For the implementation of information and instruction obligations as well as for the maintenance work the following documents are available. They must be submitted to (intermediate) dealers and manufacturers and to the end customer.

Planning documentation

Product catalogues

Installation Instructions

Maintenance and care instructions as well as operating instructions

7. Use of type-related fittings















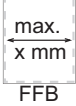

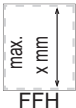
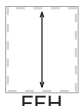
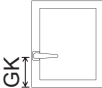
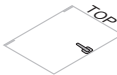
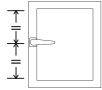

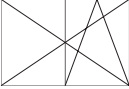

The variants for the individual fitting systems (e.g. tilt and top-hung sash fittings or parallel action fittings providing an additional ventilation position by means of a circumferential gap all around the sash) are to be handled accordingly with regard to product information and intended use, misuse, product performance, product maintenance, information and instruction obligations depending on the applicable characteristics.

8. Storage

Before the fitting components are assembled, they must be stored on a dry, protected and level surface.

1

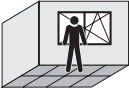
Declaration of symbols

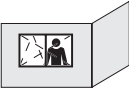
	Max. Sash weight: x kg		Basic set of fittings
	Max. Sash size: x m ²		Optional fittings
	Max. Sash rebate width (FFB): x mm		Size-dependent fittings depending on sash rebate width (FFB)
	Max. Sash rebate height (FFH): x mm		Size-dependent fittings depending on sash rebate height (FFH)
	Constant handle height		"TOP" marks the upper edge of the window.
	Central handle height		Pot hinge version
	Turn sash (D)		Rebate hinge version
	Turn-tilt sash (DK)		Item for use on PVC-U windows
	Turn/Turn-tilt double sash (D/DK-Stulp)		Item for use on wooden windows with 12 mm airgap
	Design of centre turn sash (D) (3-sash units)		Item for use in wooden windows with 4 mm airgap and 15 mm overlap
	Parallel action		Item for use in wooden windows with 4 mm airgap and 18 mm overlap
	Interior view		Item for use on aluminium windows
	Exterior view		

Packing key in the Winkhaus logistics system

The shipping units are configured in a way to enable you easy handling of our products in your works from small boxes to bulky pallets. For instance, we provide KLTs (small load carriers) in different sizes which are eco-friendly and facilitate logistics. The reusable packaging units, which can be stacked on a europallet, have a bar code and enable optimal stock organisation and easy transport to the relevant workstations. The packaging used for the products in question can be found on the corresponding product pages.



BL Goods packed in PE bags with bar code



KT Goods packed in cardboard boxes with bar code



BD Tied goods with barcode



K3 Small cardboard box with bar code. Dim: 395 x 295 x 205 mm

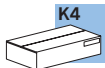

K4 Big cardboard box with bar code. Dim: 595 x 395 x 205 mm



KK Small KLT (small load carrier) 4321. Dim: 400 x 300 x 214 mm with cover, bar code, sealed, stackable



GK Big KLT (small load carrier) 6412. Dim: 600 x 400 x 214 mm with cover, bar code, sealed, stackable

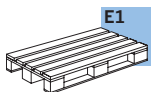

E1 europallet with KLT
Pallet size 800 x 1,200 mm

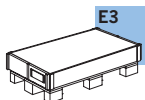

E3 One-way pallet with cover box and bar code

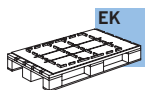

EK Europallet with KLT and fixing plate (avoids shifting of goods)
Pallet size 800 x 1,200 mm



EA Europallet with frame and bar code
Pallet size 800 x 1,200 mm

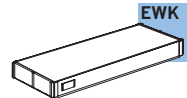

EWK Disposable cardboard box E3, L6 or L7

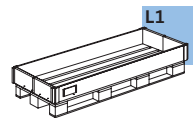

L1 Reusable pallet for long goods with frame and bar code
Pallet size 800 x 1,800 mm

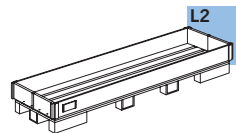

L2 Reusable pallet II for long goods with frame and bar code
Pallet size 800 x 2,400 mm

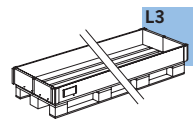

L3 Reusable pallet III for long goods with frame and bar code
Pallet size 800 x 3,500 mm

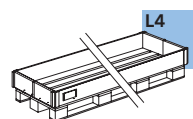

L4 Reusable pallet IV for long goods with frame and bar code
Pallet size 800 x 4,200 mm

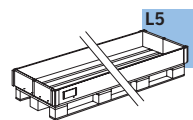

L5 Reusable pallet V for long goods with frame and bar code
Pallet size 800 x 6,500 mm

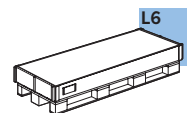

L6 One-way pallet with cover box for long goods with bar code
Pallet size 800 x 1,800 mm

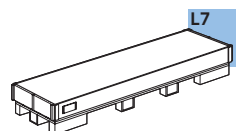

L7 One-way pallet with cover box for long goods with bar code
Pallet size 800 x 2,400 mm

1

Glossary

Code

AB.G.D	Drilling protection	GAVM	Locking drive rod activPilot, central handle position
ADS	Cover strip	GG	Handle set
ADP	Adapter	GK	Constant handle position
AKR	Automatic shootbolt	GRT.RB	Round arch set
AL...	Support plate		
ANS	Mounting element		
AP.HH	Fitting punch, lever	HC	Timber windows, rebate version
AP...SE	Adapter plate, activPilot Select	HFG	Window Handle Case HFG
AS.DSL	Mini ventilation unit (turn position)	HT	Timber windows, pot hinge version
AS.SBA	Mini vent keep		
ASP ER-A	End plate		
ASS AR	Connecting rail	IF	activPilot Topstar
AWDR	Stroke limiter		
BK	Balcony door catch	K.EL	Corner hinge cap
BK.KR	Catch bolt	K.FL	Sash hinge cover
BO	Catch bolt	K.SB	Shear hinge cap, timber
BS	Threshold	K.SK	Shear hinge insert cap
BST AP/FS	Fittings punch	K.SL	Shear hinge cover
		KB	Tilt hinge
		KBG	Tilt limiter
D	Backset	KE	Coupling element
DB	Turn limiter	KLB	Tilt hinge insert
DBG	Turn limiter	KR	Shootbolt
DFE	Dual function element	KUE-T1	Cable transition, separable
DL	Turn hinge insert		
DL...ET	Turn hinge, 1 piece	LE.B	Drill jig
DLW ERW	Turn hinge bracket	LE.FR	Milling jig
DML	Turn middle hinge	LE.N	Jig
DS	Window lock	LIN AP/FS	Ruler of fittings press
		LM-RG	Round handle
E	Corner drive	M	Interlocking rod
E1.A	Corner drive for studio windows	MK	Interlocking rod, extendable
E1.MSL	Corner drive with variable tilt device	MS.SO	Interlocking rod, double sash, keep top
E1.SBS	Corner drive for double-sash window		
EL	Corner hinges	MS.SU	Interlocking rod, double sash, keep bottom
ELK	Corner hinge cap	MSL.OS	Variable tilt device top rod
FBP	Window limiter		
FH ...	Sash lifter	NML	Groove centre position
FL	Sash hinges		
FL...PADS	Sash hinge, PADS	OBV	Opening limiter
FL...PAD/ PADM	Sash hinge PAD/PADM	OS	Top rod
FL...PADK	Sash hinge, PADK	OS...PA...	Top rod, PADK
FLK	Sash hinge cover	OS. ...E	Top rod (turn before tilt)
FLS.SE	Sash hinge rail, activPilot Select	OS.A	Screw clip
FSA	Fail safe device FSA		
FSF	Fail safe device FSF		
FSR	Rebate shear	PA	Parallel action
FT	Spacer	PAD	Parallel action, turn
		PADK	Parallel action, turn-tilt
GAK	Drive rod, constant handle position	RA.DB.SE	Frame connection turn limiter
GAKA	Drive rod, constant handle position, lockable	RT.DFE-TFE	Frame part, dual/triple function element
GAM	Drive rod, central handle position	RT.DFE-TFE.S	Frame part, dual/triple function element, double-sash windows
GAMA	Drive rod, central handle position, lockable		
GASK	Double sash drive rod, constant handle position	RT.MSL	Frame part, variable tilt device
GASM	Double sash drive rod, central handle position		

Item description

S.FL	Sash hinge plug	...LS	Fitting direction left
SA	Shootbolt keeps	...RS	Fitting direction right
SA.IF	Shear activPilot Topstar aluminium	...AGR	anthracite grey (similar to RAL 7016)
SB SZV	Keep, claw bolt	...BR	brown (similar to RAL 8019)
SBA...	Keep, contact pressure	...BZ-AM	bronze - antique brass
SBA...T	Mini vent keep	...BZ-CU	bronze - coppery
SBK	Security tilt keep	...BZ-RB	bronze - red brown
SBK...E	Tilt keep (tilt before turn)	...CW	cream white (similar to RAL 9001)
SBK...PA	Tilt keep (with slider), PADK	...EV1	anodised silver
SBK...SP	Security tilt keep with gap locking device	...F1	silver coloured
SBS...	Security keep	...F1-elox	(similar to F1) anodised silver
SBS...PA	Security keep, PADK	...F3	gold coloured
SBS...PAB	Security keep PAB, PADK	...F3-MG	gold mat
SBS...PAD	Security keep PAD	...F9	titanium coloured
SC	Shear, rebate hinge	...LBR	clay brown
SC...A	Shear studio window	...PW	pearl white (similar to RAL 1013)
SC...E	Shear (tilt before turn)	...SG	silver-grey (similar to RAL 7001)
SC...PA...	Shear, PADK	...SGB	grey (similar to RAL 9006)
SC...PAD...	Shear PAD	...SGR	grey (similar to RAL 7037)
SCO	Shear, without turn restriction	...SL	silver look (zinc galvanised)
SE	activPilot Select	...SW	jet black
SH...T	Shear, pot hinge	...WS	white (similar to RAL 9016)
SH.IF	Shear activPilot Topstar Timber		
SK.IF	Shear activPilot Topstar PVC-U		
SL	Shear hinge		
SL.HC	Shear hinge, timber rebate hinge		
SLK	Shear hinge cap, rebate hinge		
SNH	Faceplate fastener		
SP R	Faceplate		
SR	Control unit SR		
SZP	Geared cover plate		
TFE	Triple function element		
UEB	Overlap		
UF	Packer		
V	Distance between locking points		
VBST	Connection piece		
V.AK	Extension rod		
VK.AK	Extension rod, extendable		
VS R	Connection rod		
VS RB	Connection rod round-arch window		
XL	Components from activPilot Giant range		
ZSR	Additional shear		
ZSRE	Additional shear (tilt before turn)		
ZSS	Anti-slam device		
ZV...	Claw bolt		
ZV.RT	Claw bolt, frame part		

1

Guidelines for using application diagrams

• Prerequisites:

- When fixing load-bearing components, please consider the TBDK guidelines. The tractive forces shown in the table have to be achieved. The suitable proof must be provided by the window manufacturer.
- The values given here apply to the shear hinge. An extra test of the corner hinge is not necessary in case the fixing situation is identical to that of the shear hinge.

• Please control:

- Are window dimensions within the range highlighted in grey?
- Is the intersection point to be determined located to the left of the limiting curve of the glass weight?

• Example:

Intended window dimensions:

- FFB = 1.100 mm
- FFH = 1.800 mm
- GG = 40 kg/m² (corresponds to the cyan curve)

The intersection point "S" is located in the area highlighted in grey and to the left of the limiting curve of the filling weight (GG = 40 kg/m²), i. e. in the permitted area.

• General notes:

On the establishment of application diagrams, the following values were considered:

- Glass weight GG - 2.5 kg/m² per mm of glass thickness
- Profile weight - 3.25 kg/RM

Please find more detailed information on the website <http://www.ift-service.de/awd/ift/start.faces> as well as on <http://www.fvsb.de/ggsb/richtlinien.asp>.

m [kg]	F [N]
50	1400
60	1650
70	1900
80	2200
90	2450
100	2710
110	3000
120	3250
130	3525
140	3900
150	4200

m [kg] = max. sash weight in kg
 F [N] = tractive force on the shear hinge in N



activPilot Topstar

Application diagram for ascertaining the admissible sash sizes

Max. Sash weight 130 kg



PVC

For PVC-u windows



Turn sash (D)



Turn-tilt sash (DK)

Width-to-height ratio and additional load

Value calculated without additional load for a width-to-height ratio of 2:1. The application graphs have been calculated without additional loads. Please consult your authorised contact person for further information on how to calculate the maximum permissible window sash format with an additional load.

Advice for use

The application range permitted for using Winkhaus fitting is highlighted in grey in the application graphs. However, it is essential not to use the entire grey-highlighted section, but only those parts which are on the left-hand side of the curve for the respective GG filling weight.

Application range

The respective overall fitting must be selected from the original Winkhaus activPilot fitting components range. Winkhaus accepts no liability if non-original or unauthorised system accessory parts are used.

- Min. Sash rebate width 380 mm
- Max. Sash rebate width 1725 mm
- From 1475 mm sash rebate width with additional shear ZSR
- Min. Sash rebate height 230 mm
- Max. Sash rebate height 2800 mm
- Max. Sash size 3 m²
- Ratio between sash rebate width: sash rebate height $\leq 2:1$
- Airgap at bottom side 12 +1 mm

Conditions for using the application diagram:

Proof of fixing the load-bearing components on the window system by the window manufacturer according to the TBDK guideline and with the following forces:

- For a max. sash weight of 130 kg
- On the shear hinge: 3525 N
- On the corner hinge: 3760 N

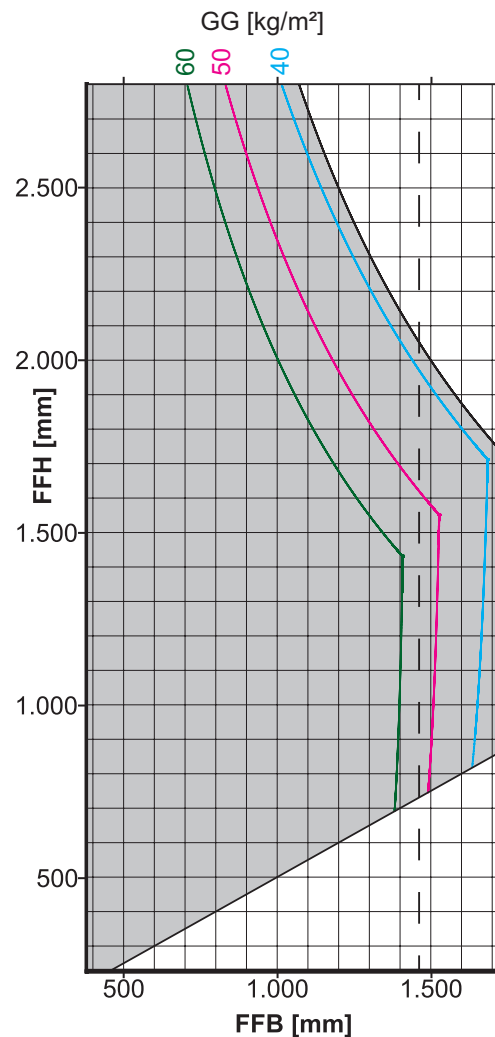

AWD_01.50_NR30_DK_130 kg_ohne_Zusatzlast_2_m

Abbreviations

- FFB = Sash rebate width [mm]
- FFH = Sash rebate height [mm]
- GG = Glass weight per square metre [kg/m²]
- ZSR = Additional shear (section on right of interrupted line)

Observe instructions on window profile

You must specifically take into account information provided by the profile manufacturer or system owner when determining the maximum sash sizes and sash weights!



Important: The screw connections of the load-bearing fitting components, such as corner, shear and sash hinges must be performed according to the TBDK guidelines. Adapt the drilling diameter for the fixing screws, the screw diameter and the screw length to the load situation.

1

activPilot Topstar

Application diagram for ascertaining the admissible sash sizes

Max. Sash weight 80 kg

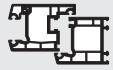

PVC

For PVC-U windows with 12 mm airgap

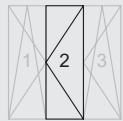

Design of centre turn sash (D)
(3-sash units)

Width-to-height ratio and additional load

Value calculated without additional load for a width-to-height ratio of 2:1. The application graphs have been calculated without additional loads. Please consult your authorised contact person for further information on how to calculate the maximum permissible window sash format with an additional load.

Advice for use

The application range permitted for using Winkhaus fitting is highlighted in grey in the application graphs. However, it is essential not to use the entire grey-highlighted section, but only those parts which are on the left-hand side of the curve for the respective GG filling weight.

Application range

The respective overall fitting must be selected from the original Winkhaus activPilot fitting components range. Winkhaus accepts no liability if non-original or unauthorised system accessory parts are used.

- Min. Sash rebate width 380 mm
- Max. Sash rebate width 1100 mm
- Min. Sash rebate height 230 mm
- Max. Sash rebate height (FFH): 2800 mm
- Max. Sash size 3 m²
- Max. Sash weight 80 kg
- Ratio between sash rebate width: sash rebate height \leq 2:1
- Airgap top and bottom in horizontal position 12 +1 mm

Conditions for using the application diagram:

Proof of fixing the load-bearing components on the window system by the window manufacturer according to the TBDK guideline and with the following forces:

- For a max. sash weight of 80 kg
- On the shear: 2200 N
- On the corner hinge: 2310 N

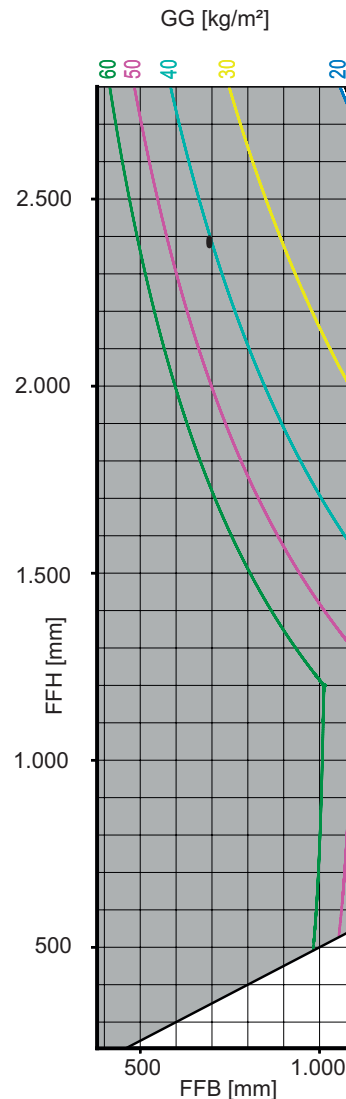

AWD_01.50_NR390_DK_80 kg_ohne_Zusatzlast_2_m

Abbreviations

- FFB = Sash rebate width [mm]
- FFH = Sash rebate height [mm]
- GG = Glass weight per square metre [kg/m²]

Observe instructions on window profile

You must specifically take into account information provided by the profile manufacturer or system owner when determining the maximum sash sizes and sash weights!



Important: The screw connections of the load-bearing fitting components, such as corner, shear and sash hinges must be performed according to the TBDK guidelines. Adapt the drilling diameter for the fixing screws, the screw diameter and the screw length to the load situation.

Overview of min. dimensions for drive rods D = 15.5 mm

The following overview shows the applications supported by top corner drives. Use depends on the variant "tilt & turn" or "turn double sash", and the window size. Depending on the application, other elements can be used as alternatives to top corner drives. If the sash rebate height is smaller than 750 mm, the airgap in the shear area must be 12 mm at least.

Turn-tilt type, constant, single sash

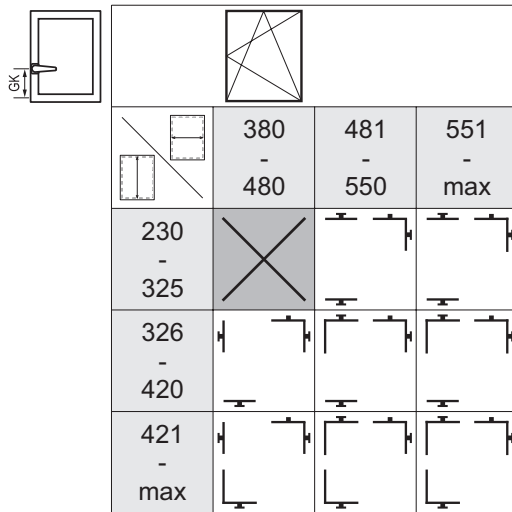

	380 - 480	481 - 550	551 - max	
230 - 325				
326 - 420				
421 - max				

Turn/Turn-tilt double sash type, constant

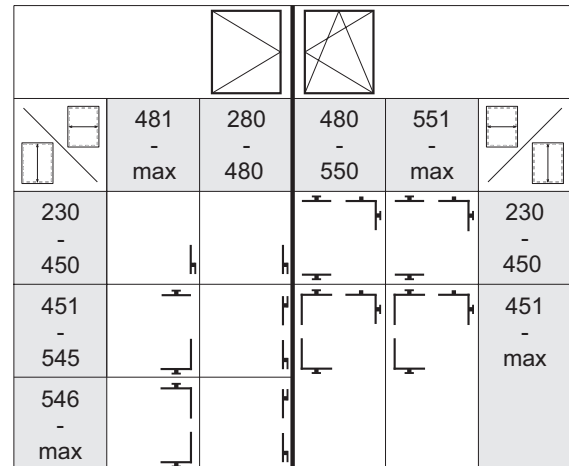

	481 - max	280 - 480	480 - 550	551 - max	
230 - 450					230 - 450
451 - 545					451 - max
546 - max					

Turn-tilt type, central, single sash

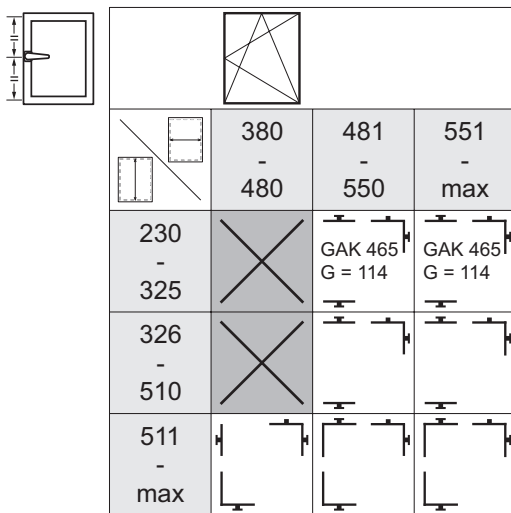

	380 - 480	481 - 550	551 - max	
230 - 325		GAK 465 G = 114	GAK 465 G = 114	
326 - 510				
511 - max				

E1 E1.SE E3 KR

Turn/Turn-tilt double sash type, central

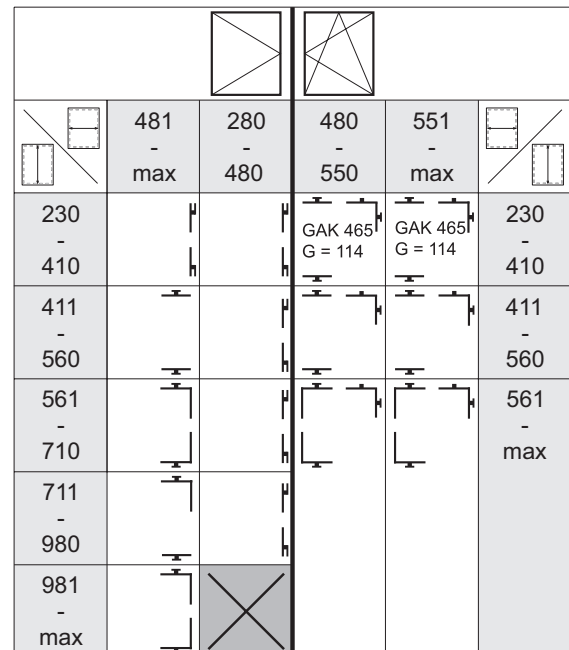

	481 - max	280 - 480	480 - 550	551 - max	
230 - 410			GAK 465 G = 114	GAK 465 G = 114	230 - 410
411 - 560					411 - 560
561 - 710					561 - max
711 - 980					
981 - max					

1

Overview of min. dimensions for drive rods D = 7.5 mm





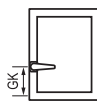

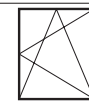
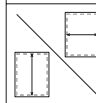
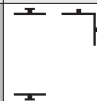
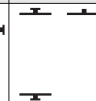
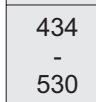
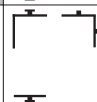
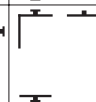
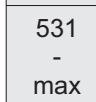
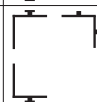
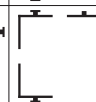
The following overview shows the applications supported by top corner drives. Use depends on the variant "tilt & turn" or "turn double sash", and the window size. Depending on the application, other elements can be used as alternatives to top corner drives. If the sash rebate height is smaller than 750 mm, the airgap in the shear area must be 12 mm at least.

Turn-tilt type, constant, single sash

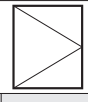

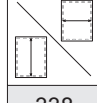

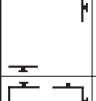
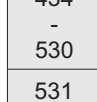

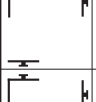
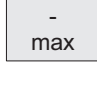
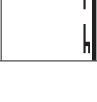
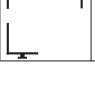
			
	380 - 480	481 - 550	551 - max
338 - 433	X		
434 - 530			
531 - max			

Turn/Turn-tilt double sash type, constant

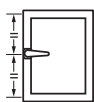
			
	481 - max	280 - 480	480 - 550
338 - 433			
434 - 530			
531 - max			



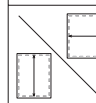
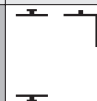
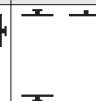
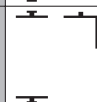

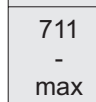
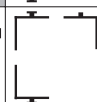
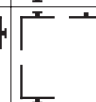



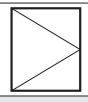

Turn-tilt type, central, single sash

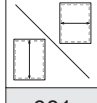

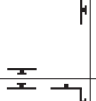
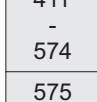
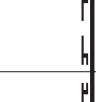
			
	380 - 480	481 - 550	551 - max
381 - 574	X		
575 - 710	X		
711 - max			

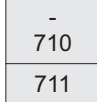
E1 E1.SE E3 KR

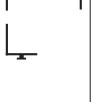
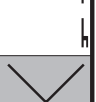
Turn/Turn-tilt double sash type, central

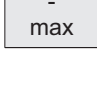
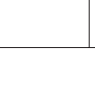

			
	481 - max	280 - 480	480 - 550
381 - 410			
411 - 574			
575 - 710			
711 - 980	GASM 1050		
981 - max		X	

Overview of max. dimensions for drive rods D = 15.5 and 7.5 mm

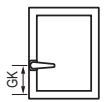

This overview shows how the gear side is designed when tall windows up to 2,725/2,800 mm are involved. The maximum sash height depends on the position of the window handle, central or constant.

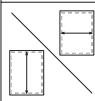
Turn-tilt type, constant, single sash

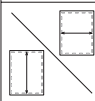

	
	min - max*
2226 - 2475	MK.250-1 + GAK.2225-...
2476 - 2725	MK.500-1 + GAK.2225-...

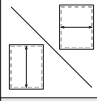
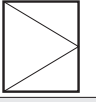
Turn/Turn-tilt double sash type, constant

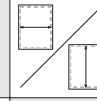
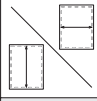
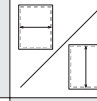

			
	min - max*	min - max*	
2226 - 2475	MS.SO.250-1 + GASK.2225-...	MK.250-1 + GAK.2225-...	2226 - 2475
2476 - 2725	MS.SO.500-1 + GASK.2225-...	MK.500-1 + GAK.2225-...	2476 - 2725

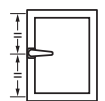
Turn-tilt type, central, single sash

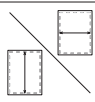
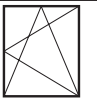
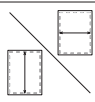

	
	min - max*
2301 - 2800	MK.250-1 + GAM.2300-3 + MK.250-1

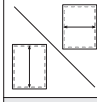
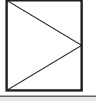
Turn/Turn-tilt double sash type, central

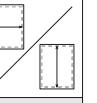
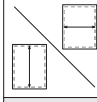
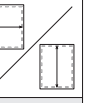
			
	min - max*	min - max*	
2301 - 2800	MS.SO.250-1 + GASM.2300-3 + MS.SU.250-1	MK.250-1 + GAM.2300-3 + MK.250-1	2301 - 2800

* Please observe the "Diagrams to determine permissible sash sizes"!

1

Lists of profiles

In order to ensure easy and secure installation, all hinge parts have a profile adjustment.





The attribution of individual items to various profiles is depicted in the following table.

Aluplast

Ideal 2000 3000

NML 13 mm

UEB 20 mm





EL 		SK 		DL 		RA 	
EL.K.IF-N.166.LS	5100453	SK.IF-N.166.LS	5100542	DL.K.IF-N.166.LS	5100806	RA.DB.K.IF.166.LS	5077814
EL.K.IF-N.166.RS	5100452	SK.IF-N.166.RS	5100541	DL.K.IF-N.166.RS	5100805	RA.DB.K.IF.166.RS	5077813

Aluplast

Ideal 4000 8000, Energeto, Energeto Neo

NML 13 mm

UEB 20 mm





EL 		SK 		DL 		RA 	
EL.K.IF-N.161.LS	5100521	SK.IF-N.161.LS	5100568	DL.K.IF-N.161.LS	5100814	RA.DB.K.IF.161.LS	5077822
EL.K.IF-N.161.RS	5100520	SK.IF-N.161.RS	5100565	DL.K.IF-N.161.RS	5100813	RA.DB.K.IF.161.RS	5077821
EL.K.IF-N.3.161.LS	5101758			DL.K.IF-N.3.161.LS	5101782		
EL.K.IF-N.3.161.RS	5101757			DL.K.IF-N.3.161.RS	5101781		

Brüggmann / Salamander

System AD

NML 13 mm

UEB 20 mm





EL 		SK 		DL 		RA 	
EL.K.IF-N.152.LS	5100519	SK.IF-N.152.LS	5100607	DL.K.IF-N.152.LS	5100820	RA.DB.K.IF.152.LS	5077816
EL.K.IF-N.152.RS	5100464	SK.IF-N.152.RS	5100606	DL.K.IF-N.152.RS	5100819	RA.DB.K.IF.152.RS	5077815
		SK.IF-N.E.152.LS	5100790				
		SK.IF-N.E.152.RS	5100789				

Brüggmann / Salamander

System MD

NML 13 mm

UEB 20 mm





EL 		SK 		DL 		RA 	
EL.K.IF-N.152.LS	5100519	SK.IF-N.152.LS	5100607	DL.K.IF-N.152.LS	5100820	RA.DB.K.IF.152.LS	5077816
EL.K.IF-N.152.RS	5100464	SK.IF-N.152.RS	5100606	DL.K.IF-N.152.RS	5100819	RA.DB.K.IF.152.RS	5077815
		SK.IF-N.E.152.LS	5100790				
		SK.IF-N.E.152.RS	5100789				

Deceuninck

iCOR, Elegant

NML 13 mm

UEB 21 mm





EL 		SK 		DL 		RA 	
EL.K.IF-N.169.LS	5100451	SK.IF-N.169.LS	5100538	DL.K.IF-N.169.LS	5100804	RA.DB.K.IF.169.LS	5077812
EL.K.IF-N.169.RS	5100450	SK.IF-N.169.RS	5100537	DL.K.IF-N.169.RS	5100803	RA.DB.K.IF.169.RS	5077811

Deceuninck

Zendow, Neo

NML 13 mm

UEB 20 mm





EL 		SK 		DL 		RA 	
EL.K.IF-N.169.LS	5100451	SK.IF-N.169.LS	5100538	DL.K.IF-N.169.LS	5100804	RA.DB.K.IF.169.LS	5077812
EL.K.IF-N.169.RS	5100450	SK.IF-N.169.RS	5100537	DL.K.IF-N.169.RS	5100803	RA.DB.K.IF.169.RS	5077811

Gealan

3000

NML 13 mm

UEB 20 mm

EL 		SK 		DL 		RA 	
EL.K.IF-N.162.LS	5100457	SK.IF-N.162.LS	5100552	DL.K.IF-N.162.LS	5100810	RA.DB.K.IF.162.LS	5077818
EL.K.IF-N.162.RS	5100456	SK.IF-N.162.RS	5100545	DL.K.IF-N.162.RS	5100809	RA.DB.K.IF.162.RS	5077817
		SK.IF-N.E.162.LS	5100786				
		SK.IF-N.E.162.RS	5100784				

Lists of profiles

1

In order to ensure easy and secure installation, all hinge parts have a profile adjustment.
The attribution of individual items to various profiles is depicted in the following table.

Gealan 6000, 7000, 8000, 9000

NML 13 mm
UEB 20 mm

EL		SK		DL		RA	
EL.K.IF-N.162.LS	5100457	SK.IF-N.162.LS	5100552	DL.K.IF-N.162.LS	5100810	RA.DB.K.IF.162.LS	5077818
EL.K.IF-N.162.RS	5100456	SK.IF-N.162.RS	5100545	DL.K.IF-N.162.RS	5100809	RA.DB.K.IF.162.RS	5077817
		SK.IF-N.E.162.LS	5100786				
		SK.IF-N.E.162.RS	5100784				

Gealan Kubus

NML 13 mm
UEB 20 mm

EL		SK		DL		RA	
EL.K.IF-N.262.LS	5100463	SK.IF-N.262.LS	5100605	DL.K.IF-N.262.LS	5100818	RA.DB.K.IF.262.LS	5077826
EL.K.IF-N.262.RS	5100462	SK.IF-N.262.RS	5100603	DL.K.IF-N.262.RS	5100817	RA.DB.K.IF.262.RS	5077825

KBE (Profine) 70 AD / 70 MD / 88+

NML 13 mm
UEB 20 mm

EL		SK		DL		RA	
EL.K.IF-N.205.LS	5100459	SK.IF-N.205.LS	5100560	DL.K.IF-N.205.LS	5100812	RA.DB.K.IF.205.LS	5077820
EL.K.IF-N.205.RS	5100458	SK.IF-N.205.RS	5100557	DL.K.IF-N.205.RS	5100811	RA.DB.K.IF.205.RS	5077819
		SK.IF-N.E.205.LS	5100788				
		SK.IF-N.E.205.RS	5100787				

KBE (Profine) 76 AD, 76 MD

NML 13 mm
UEB 20 mm

EL		SK		DL		RA	
EL.K.IF-N.205.LS	5100459	SK.IF-N.205.LS	5100560	DL.K.IF-N.205.LS	5100812	RA.DB.K.IF.205.LS	5077820
EL.K.IF-N.205.RS	5100458	SK.IF-N.205.RS	5100557	DL.K.IF-N.205.RS	5100811	RA.DB.K.IF.205.RS	5077819
		SK.IF-N.E.205.LS	5100788				
		SK.IF-N.E.205.RS	5100787				

Kömmerling (Profine) 76 AD, 76 MD

NML 13 mm
UEB 20 mm

EL		SK		DL		RA	
EL.K.IF-N.205.LS	5100459	SK.IF-N.205.LS	5100560	DL.K.IF-N.205.LS	5100812	RA.DB.K.IF.205.LS	5077820
EL.K.IF-N.205.RS	5100458	SK.IF-N.205.RS	5100557	DL.K.IF-N.205.RS	5100811	RA.DB.K.IF.205.RS	5077819
		SK.IF-N.E.205.LS	5100788				
		SK.IF-N.E.205.RS	5100787				

LB.Profile PAD / PMD / PCD

NML 13 mm
UEB 20 mm





EL		SK		DL		RA	
EL.K.IF-N.152.LS	5100519	SK.IF-N.152.LS	5100607	DL.K.IF-N.152.LS	5100820	RA.DB.K.IF.152.LS	5077816
EL.K.IF-N.152.RS	5100464	SK.IF-N.152.RS	5100606	DL.K.IF-N.152.RS	5100819	RA.DB.K.IF.152.RS	5077815
		SK.IF-N.E.152.LS	5100790				
		SK.IF-N.E.152.RS	5100789				

1





Lists of profiles

In order to ensure easy and secure installation, all hinge parts have a profile adjustment.
The attribution of individual items to various profiles is depicted in the following table.





Rehau Euro-Design 86 NML 13 mm
UEB 20 mm

EL 		SK 		DL 		RA 	
EL.K.IF-N.128.LS	5100461	SK.IF-N.128.LS	5100574	DL.K.IF-N.128.LS	5100816	RA.DB.K.IF.128.LS	5077824
EL.K.IF-N.128.RS	5100460	SK.IF-N.128.RS	5100569	DL.K.IF-N.128.RS	5100815	RA.DB.K.IF.128.RS	5077823





Rehau Geneo, Synego NML 13 mm
UEB 20 mm

EL 		SK 		DL 		RA 	
EL.K.IF-N.128.LS	5100461	SK.IF-N.128.LS	5100574	DL.K.IF-N.128.LS	5100816	RA.DB.K.IF.128.LS	5077824
EL.K.IF-N.128.RS	5100460	SK.IF-N.128.RS	5100569	DL.K.IF-N.128.RS	5100815	RA.DB.K.IF.128.RS	5077823





Salamander bluEvolution 82 NML 13 mm
UEB 20 mm

EL 		SK 		DL 		RA 	
EL.K.IF-N.152.LS	5100519	SK.IF-N.152.LS	5100607	DL.K.IF-N.152.LS	5100820	RA.DB.K.IF.152.LS	5077816
EL.K.IF-N.152.RS	5100464	SK.IF-N.152.RS	5100606	DL.K.IF-N.152.RS	5100819	RA.DB.K.IF.152.RS	5077815
		SK.IF-N.E.152.LS	5100790				
		SK.IF-N.E.152.RS	5100789				





Salamander bluEvolution 92 NML 13 mm
UEB 20 mm

EL 		SK 		DL 		RA 	
EL.K.IF-N.128.LS	5100461	SK.IF-N.128.LS	5100574	DL.K.IF-N.128.LS	5100816	RA.DB.K.IF.128.LS	5077824
EL.K.IF-N.128.RS	5100460	SK.IF-N.128.RS	5100569	DL.K.IF-N.128.RS	5100815	RA.DB.K.IF.128.RS	5077823





Salamander greenEvolution NML 13 mm
UEB 20 mm

EL 		SK 		DL 		RA 	
EL.K.IF-N.152.LS	5100519	SK.IF-N.152.LS	5100607	DL.K.IF-N.152.LS	5100820	RA.DB.K.IF.152.LS	5077816
EL.K.IF-N.152.RS	5100464	SK.IF-N.152.RS	5100606	DL.K.IF-N.152.RS	5100819	RA.DB.K.IF.152.RS	5077815
		SK.IF-N.E.152.LS	5100790				
		SK.IF-N.E.152.RS	5100789				

Schüco Corona 70 / Corona SI 82 NML 13 mm
UEB 20 mm

EL 		SK 		DL 		RA 	
EL.K.IF-N.166.LS	5100453	SK.IF-N.166.LS	5100542	DL.K.IF-N.166.LS	5100806	RA.DB.K.IF.166.LS	5077814
EL.K.IF-N.166.RS	5100452	SK.IF-N.166.RS	5100541	DL.K.IF-N.166.RS	5100805	RA.DB.K.IF.166.RS	5077813

Schüco LivIng NML 13 mm
UEB 20 mm





EL 		SK 		DL 		RA 	
EL.K.IF-N.166.LS	5100453	SK.IF-N.166.LS	5100542	DL.K.IF-N.166.LS	5100806	RA.DB.K.IF.166.LS	5077814
EL.K.IF-N.166.RS	5100452	SK.IF-N.166.RS	5100541	DL.K.IF-N.166.RS	5100805	RA.DB.K.IF.166.RS	5077813

Lists of profiles

In order to ensure easy and secure installation, all hinge parts have a profile adjustment.
The attribution of individual items to various profiles is depicted in the following table.





Trocal (Profine)
76 AD, 76 MD

NML 13 mm
UEB 20 mm

EL 		SK 		DL 		RA 	
EL.K.IF-N.205.LS	5100459	SK.IF-N.205.LS	5100560	DL.K.IF-N.205.LS	5100812	RA.DB.K.IF.205.LS	5077820
EL.K.IF-N.205.RS	5100458	SK.IF-N.205.RS	5100557	DL.K.IF-N.205.RS	5100811	RA.DB.K.IF.205.RS	5077819
		SK.IF-N.E.205.LS	5100788				
		SK.IF-N.E.205.RS	5100787				

Veka
Softline 70 AD/MD, Softline 82 AD/MD, Softline 76 AD/MD, Artline 82

NML 13 mm
UEB 20 mm

EL 		SK 		DL 		RA 	
EL.K.IF-N.152.LS	5100519	SK.IF-N.152.LS	5100607	DL.K.IF-N.152.LS	5100820	RA.DB.K.IF.152.LS	5077816
EL.K.IF-N.152.RS	5100464	SK.IF-N.152.RS	5100606	DL.K.IF-N.152.RS	5100819	RA.DB.K.IF.152.RS	5077815
		SK.IF-N.E.152.LS	5100790				
		SK.IF-N.E.152.RS	5100789				

The window or door unit is divided into 8 sections (4 corners, 4 sides). In order to determine a complete fitting set of a certain sash size, it is necessary to ascertain items from all the sections (1). In each subarea (1), the articles to be used (4) and their item numbers (5) can be read, depending on the application area FFB (2) and FFH (3). The frame part types (6) are also supplemented with their position number (7) and quantity (8). The item numbers (5/7) refer to the position of the component within the fitting overview (page 1).

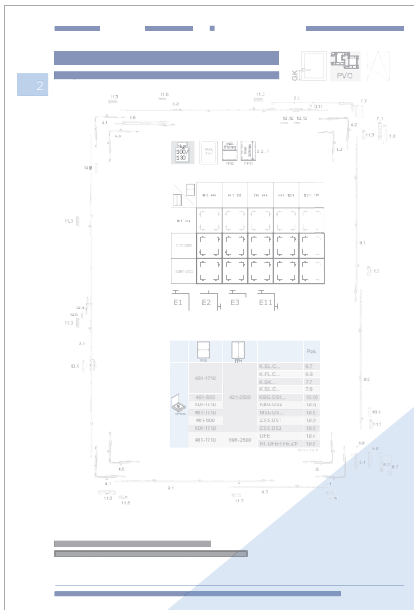

Pos.	Pos.	Pos.	Pos.
461-1710	421-2500	AB.G.D.15,5	10.1
461-920	421-460	GAK.465	3.1
461-1160	461-580	GAK.710	3.1
461-1390	581-695	GAK.830-1	3.1
461-1700	696-850	GAK.945-1	3.1
	851-1075	GAK.1100-1	3.1
	1076-1325	GAK.1325-2	3.1
	1326-1525	GAK.1550-2	3.1
	1526-1775	GAK.1775-2	3.1
	1776-2000	GAK.2000-2	3.1
	2001-2225	GAK.2225-2	3.1
	2226-2475	GAK.2225-2	3.1
	2476-2500	GAK.2225-2	3.1
461-1160	421-580	E11	4.5
461-1710	581-2500	E1	4.1

9	2	3	4	5	5	4	5	6	7	8
	FFB	FFH	AB.G.D.15,5	Pos.	Pos.	Pos.	Pos.			
i	461-1710	421-2500	AB.G.D.15,5	10.1	AL D...	10.9				
	461-920	421-460	GAK.465	3.1						
	461-1160	461-580	GAK.710	3.1						
	461-1390	581-695	GAK.830-1	3.1				SBS.K...	11.3	1x
	461-1700	696-850	GAK.945-1	3.1				SBS.K...	11.3	1x
		851-1075	GAK.1100-1	3.1				SBS.K...	11.3	1x
		1076-1325	GAK.1325-2	3.1				SBS.K...	11.3	2x
		1326-1525	GAK.1550-2	3.1				SBS.K...	11.3	3x
		1526-1775	GAK.1775-2	3.1				SBS.K...	11.3	2x
		1776-2000	GAK.2000-2	3.1				SBS.K...	11.3	2x
		2001-2225	GAK.2225-2	3.1				SBS.K...	11.3	2x
		2226-2475	GAK.2225-2	3.1	MK.250-1	9.1		SBS.K...	11.3	3x
		2476-2500	GAK.2225-2	3.1	MK.500-1	9.1		SBS.K...	11.3	3x
	461-1160	421-580	E11	4.5				SBS.K...	11.3	2x
	461-1710	581-2500	E1	4.1				SBS.K...	11.3	1x

- 1 Section (A-H)
- 2 Sash rebate width (FFB) (application ranges on items level)
- 3 Sash rebate height (FFH) (application ranges on items level)
- 4 Items to be used
- 5 Position number of items
- 6 Type of frame part
- 7 Position number of frame parts
- 8 Number of frame parts
- 9 i marks a line with items that are always used, regardless of size

Lists of Fittings

Turn-tilt fitting system – constant handle position Basic equipment	32
Turn-tilt fitting system – central handle position Basic equipment	34
Turn-tilt fitting system – constant handle position Suitable for burglary-resistant windows RC2 / RC2 N	36
Turn-tilt fitting system – central handle position Suitable for burglary-resistant windows RC2 / RC2 N	38
Turn double sash fitting system – constant handle position Basic equipment with circumferential locking points	40
Turn double sash fitting system – central handle position Basic equipment with circumferential locking points	42
Turn double sash fitting system – constant handle position Basic equipment with claw bolt	44
Turn double sash fitting system – central handle position Basic equipment with claw bolt	46
Turn double sash fitting system – constant handle position Suitable for burglary-resistant windows RC2 / RC2 N	48
Turn double sash fitting system – central handle position Suitable for burglary-resistant windows RC2 / RC2 N	50
Turn-tilt fitting system – constant handle position Basic equipment for triple-sash elements	52
Turn-tilt fitting system – central handle position Basic equipment for triple-sash elements	54
Turn-tilt fitting system – constant handle position Basic equipment – Tilt before turn	56
Turn-tilt fitting system – central handle position Basic equipment – Tilt before turn	58
Tilt fanlight Basic equipment	60

Turn-tilt fitting – constant handle position

Basic equipment

2

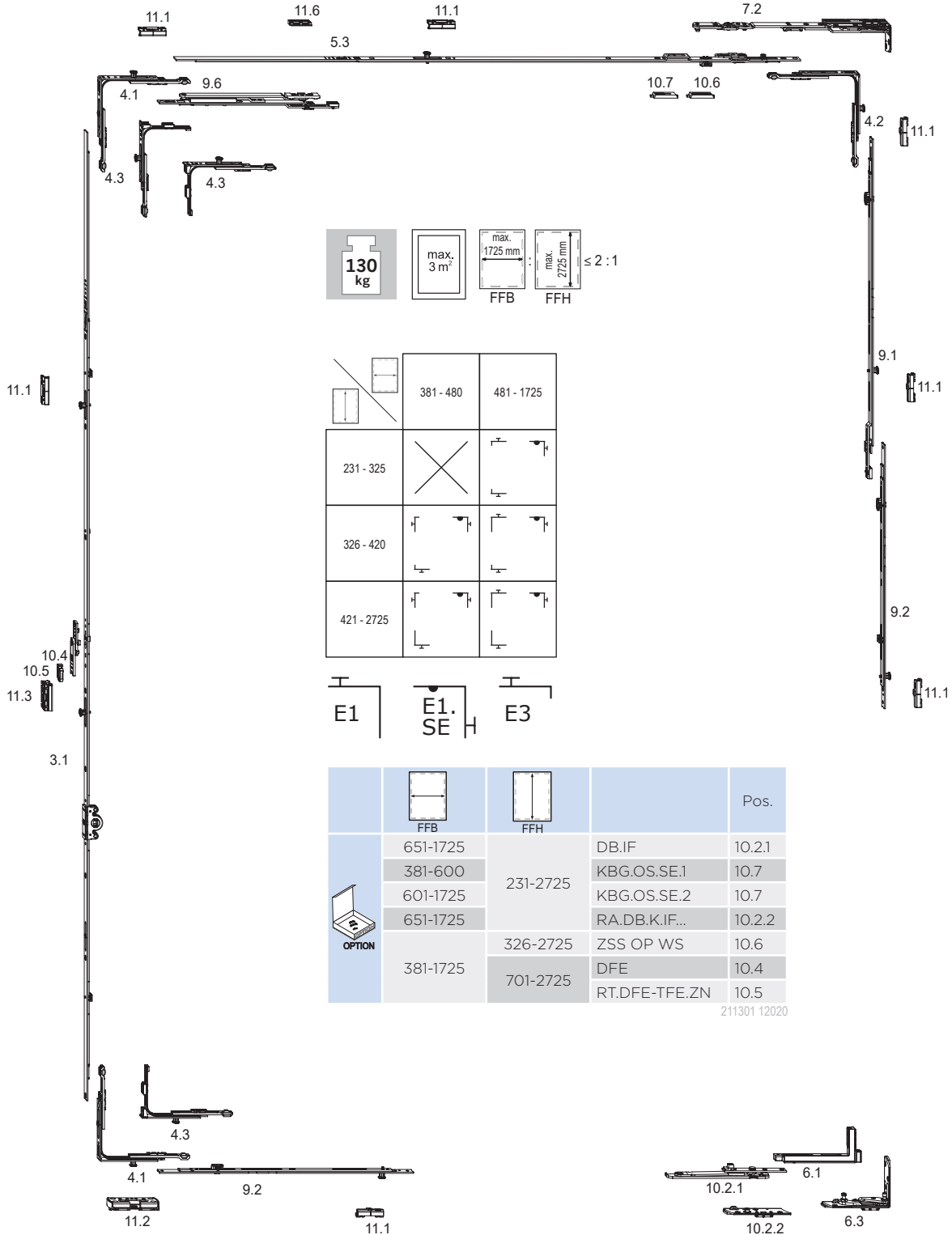
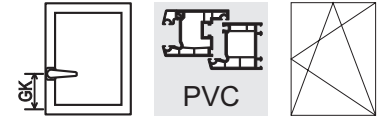







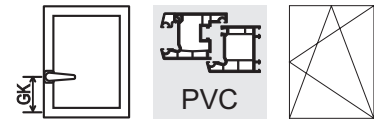



The shown distance between locking points is 800 mm.
The locking distances must be agreed with the system provider.

Turn-tilt fitting – constant handle position

Basic equipment



				Pos.		Pos.		Pos.		Pos.		
	481-650	231-325	GAK.465	3.1			GK = 114					
	381-840	326-420	GAK.465	3.1			GK = 114					
	381-920	421-460	GAK.465	3.1			GK = 210					
	381-1400	461-700	GAK.710	3.1			GK = 210					
	381-1700	701-850	GAK.945-1	3.1			GK = 260		SBS.K...	11.3	1x	
	381-1725	851-1100		GAK.1100-1	3.1			GK = 375		SBS.K...	11.3	1x
		1101-1325		GAK.1325-1	3.1			GK = 550		SBS.K...	11.3	1x
		1326-1550		GAK.1550-1	3.1			GK = 550		SBS.K...	11.3	1x
		1551-1775		GAK.1775-2	3.1			GK = 550		SBA.K... SBS.K...	11.1 11.3	1x 1x
		1776-1800		GAK.2000-2	3.1			GK = 1050		SBA.K... SBS.K...	11.1 11.3	1x 1x
		1801-2000		GAK.2000-2	3.1			GK = 1050		SBS.K... SBA.K...	11.3 11.1	1x 1x
		2001-2225		GAK.2225-2	3.1			GK = 1050		SBA.K... SBS.K...	11.1 11.3	1x 1x
		2226-2475		GAK.2225-2	3.1	MK.250-1	9.1	GK = 1050		SBA.K... SBS.K...	11.1 11.3	2x 1x
	2476-2725		GAK.2225-2	3.1	MK.500-1	9.1	GK = 1050		SBA.K... SBS.K...	11.1 11.3	2x 1x	
	381-480	326-2725	E3	4.3					SBA.K...	11.1	1x	
	481-650	231-325	E3	4.3					SBA.K...	11.1	1x	
	481-1725	326-2725	E1	4.1					SBA.K...	11.1	1x	
	381-550	326-2725	OS.SE.550	5.3								
	481-550	231-325	OS.SE.550	5.3								
	551-800		OS.SE.800	5.3								
	801-1025	231-2725	OS.SE.1025-1	5.3					SBA.K...	11.1	1x	
	1026-1250		OS.SE.1250-1	5.3					SBA.K...	11.1	1x	
	1251-1475		OS.SE.1250-1	5.3	MK.250-0	9.1				SBA.K...	11.1	1x
	1476-1500		OS.SE.1025-1	5.3	MK.250-1	9.1	ZSR SL	9.6	FT WSK... SBA.K...	11.6 11.1	1x 2x	
1501-1725	OS.SE.1250-1	5.3	MK.250-1	9.1	ZSR SL	9.6	FT WSK... SBA.K...	11.6 11.1	1x 2x			
	381-1725	326-2725	E1.SE	4.2	SK.IF-N...	7.2			SBA.K...	11.1	1x	
	481-650	231-325	E1.SE	4.2	SK.IF-N...	7.2			SBA.K...	11.1	1x	
	381-1725	861-1285	M.500-1	9.2					SBA.K...	11.1	1x	
		1286-1535	M.750-1	9.2					SBA.K...	11.1	1x	
		1536-1785	MK.500-1	9.1	M.500-1	9.2				SBA.K...	11.1	2x
		1786-2035	MK.750-1	9.1	M.500-1	9.2				SBA.K...	11.1	2x
		2036-2285	MK.750-1	9.1	M.750-1	9.2				SBA.K...	11.1	2x
		2286-2535	MK.750-1	9.1	MK.500-1	9.1	M.500-1	9.2		SBA.K...	11.1	3x
2536-2725	MK.750-1	9.1	MK.750-1	9.1	M.500-1	9.2		SBA.K...	11.1	3x		
	481-650	231-325	FL.IF-N...	6.1	EL.K.IF-N...	6.3						
	381-1725	326-2725	FL.IF-N...	6.1	EL.K.IF-N...	6.3						
	841-1250		M.500-1	9.2					SBA.K...	11.1	1x	
	1251-1500	231-2725	M.750-1	9.2					SBA.K...	11.1	1x	
	1501-1725		MK.500-1	9.1	M.500-1	9.2			SBA.K...	11.1	2x	
	381-840	326-420	E3	4.3					SBK.K...	11.2	1x	
	381-1725	421-2725	E1	4.1					SBK.K...	11.2	1x	
	481-650	231-325	E3	4.3					SBK.K...	11.2	1x	

 marks a line with items that are always used, regardless of size

Turn-tilt fitting – central handle position

Basic equipment

2

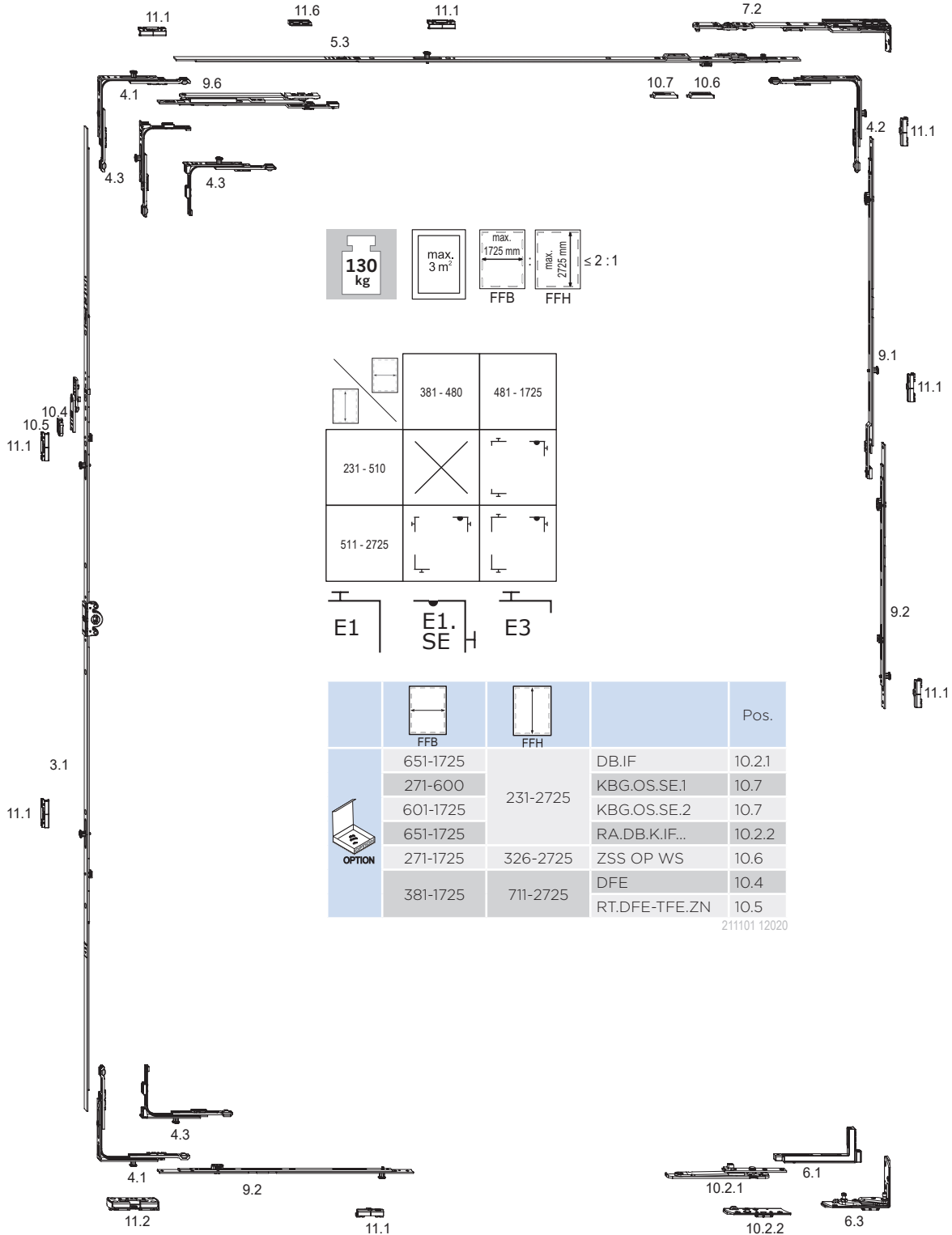
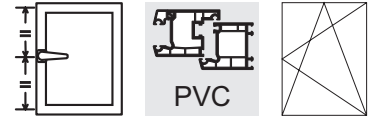

The shown distance between locking points is 800 mm.
 The locking distances must be agreed with the system provider.

Turn-tilt fitting – central handle position

Basic equipment

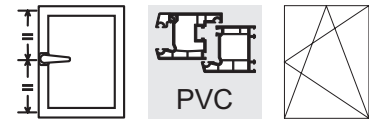

	FFB	FFH		Pos.		Pos.		Pos.		Pos.	
	481-650	231-325	GAK.465	3.1			GK = 114				
	481-1020	326-510	GAM.800	3.1							
	381-1420	511-710	GAM.800	3.1							
	381-1725	711-980	GAM.1050-1	3.1					SBA.K...	11.1	2x
		981-1400	GAM.1400-1	3.1					SBA.K...	11.1	1x
		1401-1800	GAM.1800-2	3.1					SBA.K...	11.1	2x
		1801-2300	GAM.2300-3	3.1					SBA.K...	11.1	3x
	2301-2725	GAM.2300-3	3.1	MK.250-1	9.1	MK.250-1	9.1	SBA.K...	11.1	5x	
	381-480	511-2725	E3	4.3				SBA.K...	11.1	1x	
	481-1020	231-510	E3	4.3				SBA.K...	11.1	1x	
	481-1725	511-2725	E1	4.1				SBA.K...	11.1	1x	
	381-550	511-2725	OS.SE.550	5.3							
	481-550	231-510	OS.SE.550	5.3							
	551-800	231-2725	OS.SE.800	5.3							
	801-1025		OS.SE.1025-1	5.3					SBA.K...	11.1	1x
	1026-1250		OS.SE.1250-1	5.3					SBA.K...	11.1	1x
	1251-1475		OS.SE.1250-1	5.3	MK.250-0	9.1			SBA.K...	11.1	1x
	1476-1500		OS.SE.1025-1	5.3	MK.250-1	9.1	FT WSK...	11.6	SBA.K...	11.1	2x
			ZSR SL	9.6							
1501-1725	OS.SE.1250-1		5.3	MK.250-1	9.1	FT WSK...	11.6	SBA.K...	11.1	2x	
	ZSR SL		9.6								
	381-1725	511-2725	E1.SE	4.2	SK.IF-N...	7.2		SBA.K...	11.1	1x	
	481-1020	231-510	E1.SE	4.2	SK.IF-N...	7.2		SBA.K...	11.1	1x	
	381-1725	861-1285	M.500-1	9.2				SBA.K...	11.1	1x	
		1286-1535	M.750-1	9.2				SBA.K...	11.1	1x	
		1536-1785	MK.500-1	9.1	M.500-1	9.2		SBA.K...	11.1	2x	
		1786-2035	MK.750-1	9.1	M.500-1	9.2		SBA.K...	11.1	2x	
		2036-2285	MK.750-1	9.1	M.750-1	9.2		SBA.K...	11.1	2x	
		2286-2535	MK.750-1	9.1	MK.500-1	9.1	M.500-1	9.2	SBA.K...	11.1	3x
		2536-2725	MK.750-1	9.1	MK.750-1	9.1	M.500-1	9.2	SBA.K...	11.1	3x
	481-1020	231-510	FL.IF-N...	6.1	EL.K.IF-N...	6.3					
	381-1725	511-2725	FL.IF-N...	6.1	EL.K.IF-N...	6.3					
	841-1250	231-2725	M.500-1	9.2				SBA.K...	11.1	1x	
	1251-1500		M.750-1	9.2				SBA.K...	11.1	1x	
	1501-1725		MK.500-1	9.1	M.500-1	9.2		SBA.K...	11.1	2x	
	381-1725	511-2725	E1	4.1				SBK.K...	11.2	1x	
	481-1020	231-510	E3	4.3				SBK.K...	11.2	1x	

marks a line with items that are always used, regardless of size

Turn-tilt fitting – constant handle position

Suitable for burglary-resistant windows RC2 / RC2 N

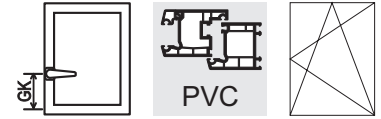

2

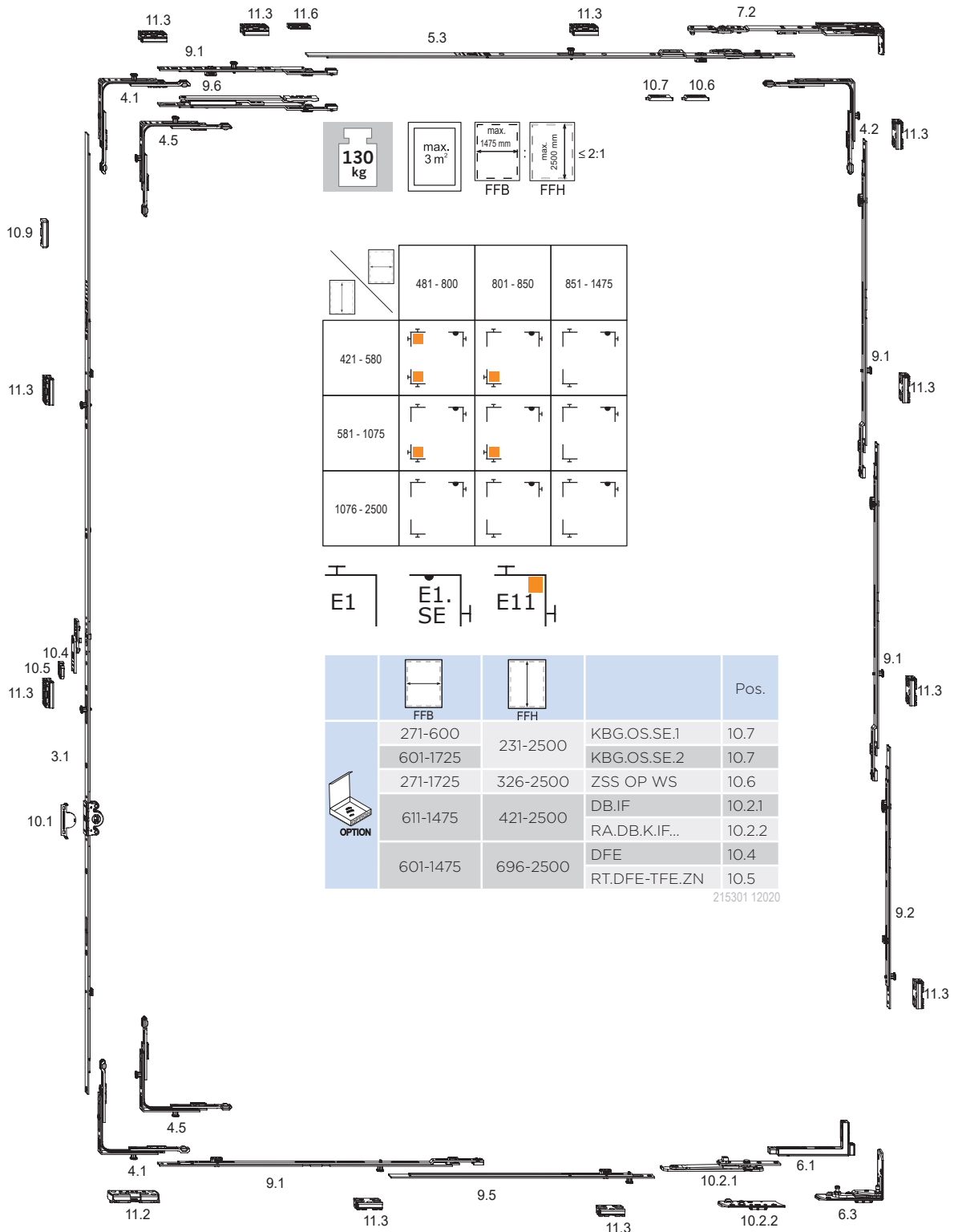

The shown distance between locking points is 800 mm.
 The locking distances must be agreed with the system provider.

Turn-tilt fitting – constant handle position

Suitable for burglary-resistant windows RC2 / RC2 N

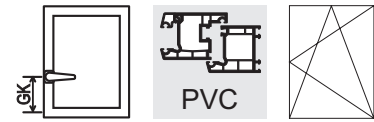

				Pos.		Pos.		Pos.		Pos.	
	i 601-1475	421-2500	AB.G.D.15,5	10.1	AL D...	10.9					
	601-920	421-460	GAK.465	3.1			GK = 210				
	601-1160	461-580	GAK.710	3.1			GK = 210				
	601-1390	581-695	GAK.830-1	3.1			GK = 260		SBS.K...	11.3	1x
	601-1475	696-850	GAK.945-1	3.1			GK = 260		SBS.K...	11.3	1x
		851-1075	GAK.1100-1	3.1			GK = 375		SBS.K...	11.3	1x
		1076-1325	GAK.1325-2	3.1			GK = 550		SBS.K...	11.3	2x
		1326-1525	GAK.1550-2	3.1			GK = 550		SBS.K...	11.3	3x
		1526-1775	GAK.1775-2	3.1			GK = 550		SBS.K...	11.3	2x
		1776-2000	GAK.2000-2	3.1			GK = 1050		SBS.K...	11.3	2x
		2001-2225	GAK.2225-2	3.1			GK = 1050		SBS.K...	11.3	2x
2226-2475	GAK.2225-2	3.1	MK.250-1	9.1	GK = 1050		SBS.K...	11.3	3x		
2476-2500	GAK.2225-2	3.1	MK.500-1	9.1	GK = 1050		SBS.K...	11.3	3x		
	601-800	421-580	E11	4.5					SBS.K...	11.3	2x
	601-1475	581-2500	E1	4.1					SBS.K...	11.3	1x
	801-1160	421-580	E1	4.1					SBS.K...	11.3	1x
	601-800	421-2500	OS.SE.800	5.3							
	801-1025		OS.SE.1025-1	5.3					SBS.K...	11.3	1x
	1026-1275		OS.SE.1025-1	5.3	MK.250-1	9.1			SBS.K...	11.3	2x
	1276-1475		OS.SE.1025-1 ZSR SL	5.3 9.6	MK.250-1	9.1	FT WSK...	11.6	SBS.K...	11.3	2x
	601-1475	421-2500	E1.SE	4.2	SK.IF-N...	7.2			SBS.K...	11.3	1x
	601-1170	421-585	M.250-1	9.2					SBS.K...	11.3	1x
	601-1475	586-1000	M.500-1	9.2					SBS.K...	11.3	1x
		1001-1200	M.750-1	9.2					SBS.K...	11.3	1x
		1201-1550	MK.500-1	9.1	M.500-1	9.2			SBS.K...	11.3	2x
		1551-1720	MK.750-1	9.1	M.500-1	9.2			SBS.K...	11.3	2x
		1721-1970	MK.500-1	9.1	MK.500-1	9.1	M.500-1	9.2	SBS.K...	11.3	3x
		1971-2220	MK.750-1	9.1	MK.500-1	9.1	M.500-1	9.2	SBS.K...	11.3	3x
		2221-2470	MK.750-1	9.1	MK.750-1	9.1	M.500-1	9.2	SBS.K...	11.3	3x
2471-2500	MK.750-1 M.500-1	9.1 9.2	MK.500-1	9.1	MK.500-1	9.1	SBS.K...	11.3	4x		
	601-1475	421-2500	FL.IF-N...	6.1	EL.K.IF-N...	6.3					
	601-850	421-2500	V.AK.450-1	9.5					SBS.K...	11.3	1x
	851-1100		V.AK.450-1	9.5	MK.250-1	9.1		SBS.K...	11.3	2x	
	1101-1360		V.AK.450-1	9.5	MK.500-1	9.1		SBS.K...	11.3	2x	
	1361-1475		V.AK.450-1	9.5	MK.750-1	9.1		SBS.K...	11.3	2x	
	601-850	421-1075	E11	4.5					SBS.K...	11.3	1x
	601-1475	1076-2500	E1	4.1					SBK.K...	11.2	1x
	851-1475	421-1075	E1	4.1					SBK.K...	11.2	1x

i marks a line with items that are always used, regardless of size

Turn-tilt fitting – central handle position

Suitable for burglary-resistant windows RC2 / RC2 N

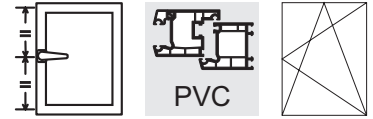

2

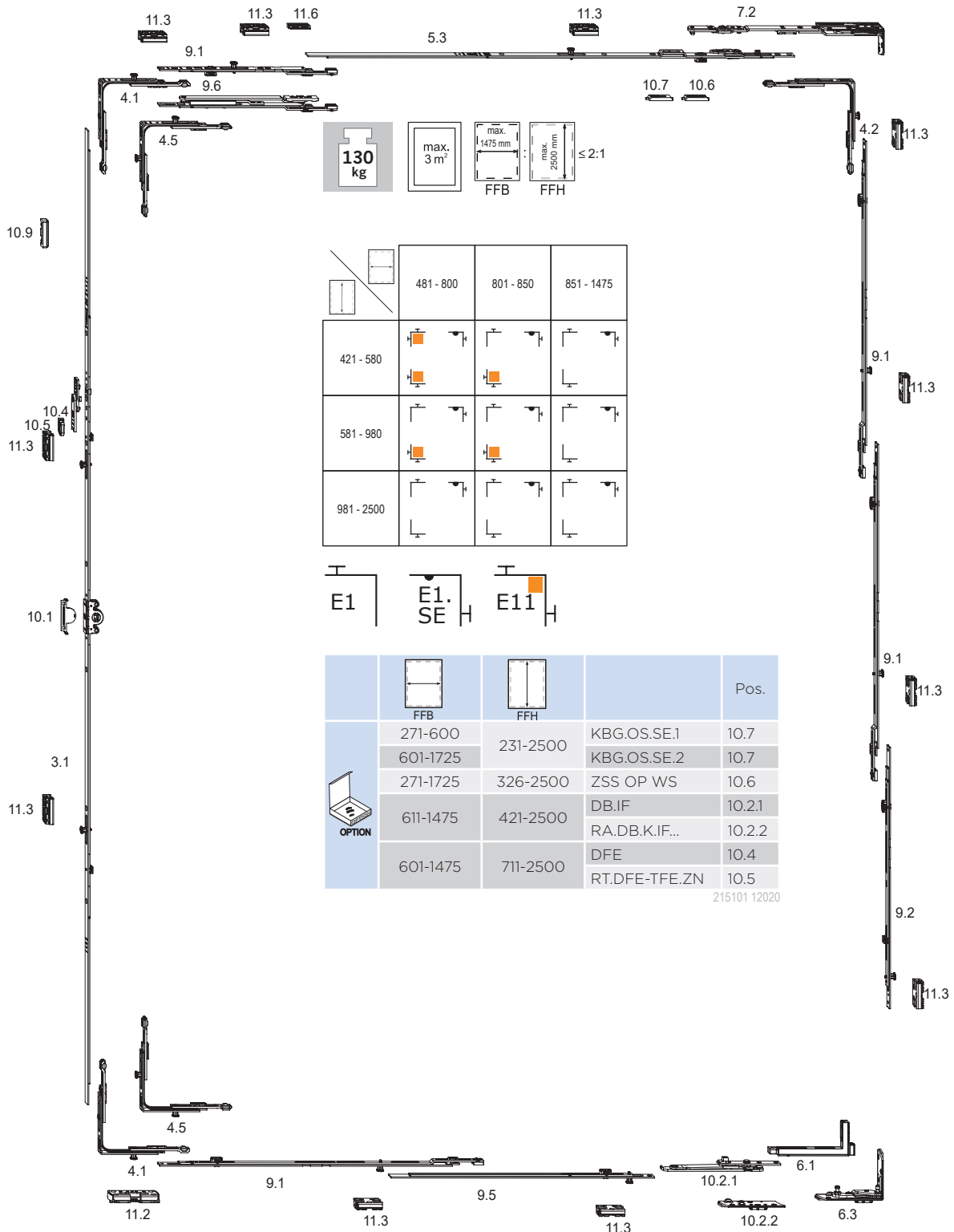







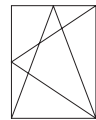
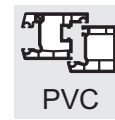
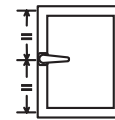



The shown distance between locking points is 800 mm.
 The locking distances must be agreed with the system provider.

Turn-tilt fitting – central handle position

Suitable for burglary-resistant windows RC2 / RC2 N









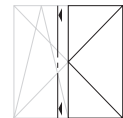
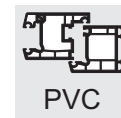



				Pos.		Pos.		Pos.		Pos.	
	i 601-1475	421-2500	AB.G.D.15,5	10.1	AL D...	10.9					
	601-920	421-460	GAK.465	3.1			GK = 210				
	601-1160	461-580	GAK.710	3.1			GK = 210				
	601-1420	581-710	GAK.830-1	3.1			GK = 260		SBS.K...	11.3	1x
	601-1475	711-980	GAM.1050-1	3.1					SBS.K...	11.3	2x
		981-1400	GAM.1400-2	3.1					SBS.K...	11.3	2x
		1401-1800	GAM.1800-2	3.1					SBS.K...	11.3	2x
		1801-2300	GAM.2300-3	3.1					SBS.K...	11.3	3x
	2301-2500	GAM.1800-2	3.1	MK.500-1	9.1	MK.500-1	9.1	SBS.K...	11.3	4x	
	601-800	421-580	E11	4.5					SBS.K...	11.3	2x
	601-1475	581-2500	E1	4.1					SBS.K...	11.3	1x
	801-1160	421-580	E1	4.1					SBS.K...	11.3	1x
	601-800	421-2500	OS.SE.800	5.3							
	801-1025		OS.SE.1025-1	5.3					SBS.K...	11.3	1x
	1026-1275		OS.SE.1025-1	5.3	MK.250-1	9.1			SBS.K...	11.3	2x
	1276-1475		OS.SE.1025-1	5.3	MK.250-1	9.1	FT WSK...	11.6	SBS.K...	11.3	2x
		ZSR SL	9.6								
	601-1475	421-2500	E1.SE	4.2	SK.IF-N...	7.2			SBS.K...	11.3	1x
	601-1170	421-585	M.250-1	9.2					SBS.K...	11.3	1x
	601-1475	586-1000	M.500-1	9.2					SBS.K...	11.3	1x
		1001-1200	M.750-1	9.2					SBS.K...	11.3	1x
		1201-1550	MK.500-1	9.1	M.500-1	9.2			SBS.K...	11.3	2x
		1551-1720	MK.750-1	9.1	M.500-1	9.2			SBS.K...	11.3	2x
		1721-1970	MK.500-1	9.1	MK.500-1	9.1	M.500-1	9.2	SBS.K...	11.3	3x
		1971-2220	MK.750-1	9.1	MK.500-1	9.1	M.500-1	9.2	SBS.K...	11.3	3x
		2221-2470	MK.750-1	9.1	MK.750-1	9.1	M.500-1	9.2	SBS.K...	11.3	3x
		2471-2500	MK.750-1	9.1	MK.500-1	9.1	MK.500-1	9.1	SBS.K...	11.3	4x
M.500-1	9.2										
	601-1475	421-2500	FL.IF-N...	6.1	EL.K.IF-N...	6.3					
	601-850	421-2500	V.AK.450-1	9.5					SBS.K...	11.3	1x
	851-1100		V.AK.450-1	9.5	MK.250-1	9.1			SBS.K...	11.3	2x
	1101-1360		V.AK.450-1	9.5	MK.500-1	9.1			SBS.K...	11.3	2x
	1361-1475		V.AK.450-1	9.5	MK.750-1	9.1			SBS.K...	11.3	2x
	601-850	421-980	E11	4.5					SBS.K...	11.3	1x
	601-1475	981-2500	E1	4.1					SBK.K...	11.2	1x
	851-1475	421-980	E1	4.1					SBK.K...	11.2	1x

i marks a line with items that are always used, regardless of size

Turn double sash fitting – constant handle position



Basic equipment with circumferential locking points

				Pos.		Pos.		Pos.		Pos.	
	481-1400	451-700	GASK.710	3.1			GK = 210				
	481-1700	701-850	GASK.945-1	3.1			GK = 260				
	481-1725	851-1100	GASK.1100-1	3.1			GK = 375				
		1101-1325	GASK.1325-1	3.1			GK = 550				
		1326-1550	GASK.1550-1	3.1			GK = 550				
		1551-1775	GASK.1775-2	3.1			GK = 550				
		1776-2000	GASK.2000-2	3.1			GK = 1050				
		2001-2225	GASK.2225-2	3.1			GK = 1050				
		2226-2475	GASK.2225-2	3.1	MS.SO.250-1	9.3	GK = 1050				
2476-2725	GASK.2225-2	3.1	MS.SO.500-1	9.3	GK = 1050						
	481-1090	451-545	E3	4.3					SBA.K...	11.1	1x
	481-1725	546-2725	E1	4.1					SBA.K...	11.1	1x
	481-550	451-2725	OS.SE.550	5.3							
	551-800		OS.SE.800	5.3							
	801-1025		OS.SE.1025-1	5.3					SBA.K...	11.1	1x
	1026-1250		OS.SE.1250-1	5.3					SBA.K...	11.1	1x
	1251-1475		OS.SE.1250-1	5.3	MK.250-0	9.1			SBA.K...	11.1	1x
	1476-1500		OS.SE.1025-1	5.3	MK.250-0	9.1	MK.250-1	9.1	SBA.K...	11.1	2x
	1501-1725		OS.SE.1250-1	5.3	MK.250-0	9.1	MK.250-1	9.1	SBA.K...	11.1	2x
	481-1725	451-2725	E1.SE	4.2	SK.IF-N...	7.2			SBA.K...	11.1	1x
	481-1725	861-1285	M.500-1	9.2					SBA.K...	11.1	1x
		1286-1535	M.750-1	9.2					SBA.K...	11.1	1x
		1536-1785	MK.500-1	9.1	M.500-1	9.2			SBA.K...	11.1	2x
		1786-2035	MK.750-1	9.1	M.500-1	9.2			SBA.K...	11.1	2x
		2036-2285	MK.750-1	9.1	M.750-1	9.2			SBA.K...	11.1	2x
		2286-2535	MK.750-1	9.1	MK.500-1	9.1	M.500-1	9.2	SBA.K...	11.1	3x
		2536-2725	MK.750-1	9.1	MK.750-1	9.1	M.500-1	9.2	SBA.K...	11.1	3x
	481-1725	451-2725	FL.IF-N...	6.1	EL.K.IF-N...	6.3					
	841-1250	451-2725	M.500-1	9.2					SBA.K...	11.1	1x
	1251-1500		M.750-1	9.2					SBA.K...	11.1	1x
	1501-1725		MK.500-1	9.1	M.500-1	9.2			SBA.K...	11.1	2x
	481-1725	451-2725	E1	4.1					SBA.K...	11.1	1x

 marks a line with items that are always used, regardless of size

Turn double-sash fitting - central handle position

Basic equipment with circumferential locking points

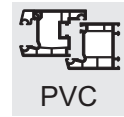

2









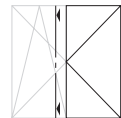
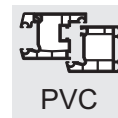



The shown distance between locking points is 800 mm.
 The locking distances must be agreed with the system provider.

Turn double-sash fitting – central handle position

Basic equipment with circumferential locking points



2

				Pos.		Pos.		Pos.		Pos.		
	481-1420	411-710	GASM.800	3.1								
	481-1725	711-980	GASM.1050-1.E3	3.1								
		981-1400	GASM.1400-1	3.1								
		1401-1800	GASM.1800-2	3.1								
		1801-2300	GASM.2300-3	3.1								
		2301-2725	GASM.2300-3	3.1	MS.SU.250-1	9.3	MS.SO.250-1	9.3				
	481-1120	411-560	E3	4.3					SBA.K...	11.1	1x	
	481-1725	561-2725	E1	4.1					SBA.K...	11.1	1x	
	481-550	411-2725	OS.SE.550	5.3								
	551-800		OS.SE.800	5.3								
	801-1025		OS.SE.1025-1	5.3						SBA.K...	11.1	1x
	1026-1250		OS.SE.1250-1	5.3						SBA.K...	11.1	1x
	1251-1475		OS.SE.1250-1	5.3	MK.250-0	9.1				SBA.K...	11.1	1x
	1476-1500		OS.SE.1025-1	5.3	MK.250-0	9.1	MK.250-1	9.1		SBA.K...	11.1	2x
	1501-1725		OS.SE.1250-1	5.3	MK.250-0	9.1	MK.250-1	9.1		SBA.K...	11.1	2x
	481-1725	411-2725	E1.SE	4.2	SK.IF-N...	7.2			SBA.K...	11.1	1x	
	481-1725	861-1285	M.500-1	9.2					SBA.K...	11.1	1x	
		1286-1535	M.750-1	9.2					SBA.K...	11.1	1x	
		1536-1785	MK.500-1	9.1	M.500-1	9.2				SBA.K...	11.1	2x
		1786-2035	MK.750-1	9.1	M.500-1	9.2				SBA.K...	11.1	2x
		2036-2285	MK.750-1	9.1	M.750-1	9.2				SBA.K...	11.1	2x
		2286-2535	MK.750-1	9.1	MK.500-1	9.1	M.500-1	9.2		SBA.K...	11.1	3x
		2536-2725	MK.750-1	9.1	MK.750-1	9.1	M.500-1	9.2		SBA.K...	11.1	3x
	481-1725	411-2725	FL.IF-N...	6.1	EL.K.IF-N...	6.3						
	841-1250	411-2725	M.500-1	9.2					SBA.K...	11.1	1x	
	1251-1500		M.750-1	9.2					SBA.K...	11.1	1x	
	1501-1725		MK.500-1	9.1	M.500-1	9.2				SBA.K...	11.1	2x
	481-1120	411-560	E3	4.3					SBA.K...	11.1	1x	
	481-1420	561-710	E1	4.1					SBA.K...	11.1	1x	
	481-1725	711-980	E3	4.3					SBA.K...	11.1	1x	
		981-2725	E1	4.1					SBA.K...	11.1	1x	

 marks a line with items that are always used, regardless of size

Turn double sash fitting – constant handle position

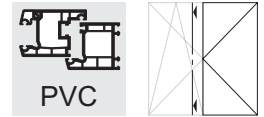

2

Basic equipment with claw bolt

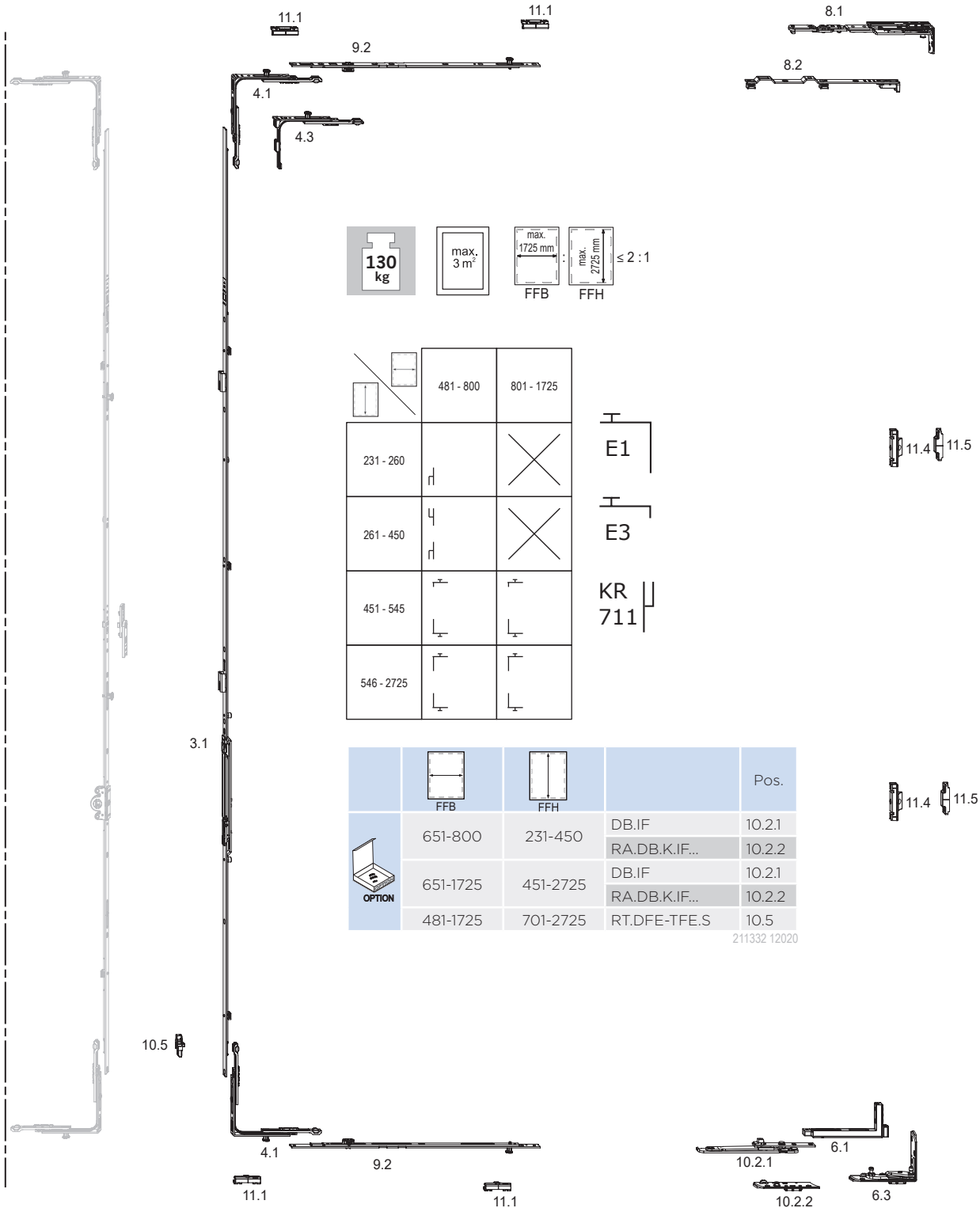

130 kg
 max. 3 m²
 max. 1725 mm
 max. 2725 mm
 $\leq 2:1$

	481 - 800	801 - 1725
	231 - 260	X
	261 - 450	X
	451 - 545	
	546 - 2725	

E1
E3
KR 711



				Pos.
	651-800	231-450	DB.IF	10.2.1
			RA.DB.K.IF...	10.2.2
	651-1725	451-2725	DB.IF	10.2.1
			RA.DB.K.IF...	10.2.2
481-1725	701-2725	RT.DFE-TF.E.S	10.5	







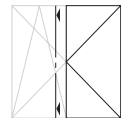
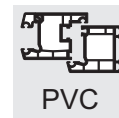



211332 12020

The shown distance between locking points is 800 mm.
The locking distances must be agreed with the system provider.

Turn double sash fitting – constant handle position



Basic equipment with claw bolt

				Pos.		Pos.		Pos.		Pos.	
	481-1400	451-700	GASK.710	3.1			GK = 210				
	481-1700	701-850	GASK.945-1	3.1			GK = 260				
	481-1725	851-1100	GASK.1100-1	3.1			GK = 375				
		1101-1325	GASK.1325-1	3.1			GK = 550				
		1326-1550	GASK.1550-1	3.1			GK = 550				
		1551-1775	GASK.1775-2	3.1			GK = 550				
		1776-2000	GASK.2000-2	3.1			GK = 1050				
		2001-2225	GASK.2225-2	3.1			GK = 1050				
		2226-2475	GASK.2225-2	3.1	MS.SO.250-1	9.3	GK = 1050				
2476-2725	GASK.2225-2	3.1	MS.SO.500-1	9.3	GK = 1050						
	481-800	261-450	KR F 711.C...	10.10					SA...	11.6	1x
	481-1090	451-545	E3	4.3					SBA.K...	11.1	1x
	481-1725	546-2725	E1	4.1					SBA.K...	11.1	1x
	841-1250	451-2725	M.500-1	9.2					SBA.K...	11.1	1x
	1251-1500		M.750-1	9.2					SBA.K...	11.1	1x
	1501-1725		MK.500-1	9.1	M.500-1	9.2			SBA.K...	11.1	2x
		481-1725	231-2725	DL.K.IF-N...	8.1	DLS.IF...	8.2				
	481-1725	801-1600	ZV-FT SL	11.4					ZV-RT...	11.5	1x
		1601-2400	ZV-FT SL	11.4	ZV-FT SL	11.4			ZV-RT...	11.5	2x
		2401-2725	ZV-FT SL	11.4	ZV-FT SL	11.4	ZV-FT SL	11.4	ZV-RT...	11.5	3x
	481-800	231-450	FL.IF-N...	6.1	EL.K.IF-N...	6.3					
	481-1725	451-2725	FL.IF-N...	6.1	EL.K.IF-N...	6.3					
	841-1250	451-2725	M.500-1	9.2					SBA.K...	11.1	1x
	1251-1500		M.750-1	9.2					SBA.K...	11.1	1x
	1501-1725		MK.500-1	9.1	M.500-1	9.2			SBA.K...	11.1	2x
	481-800	231-450	KR F 711.C...	10.10					SA...	11.6	1x
	481-1725	451-2725	E1	4.1					SBA.K...	11.1	1x

 marks a line with items that are always used, regardless of size

Turn double-sash fitting - central handle position

Basic equipment with claw bolt

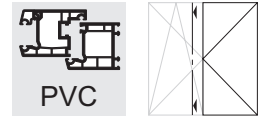

2

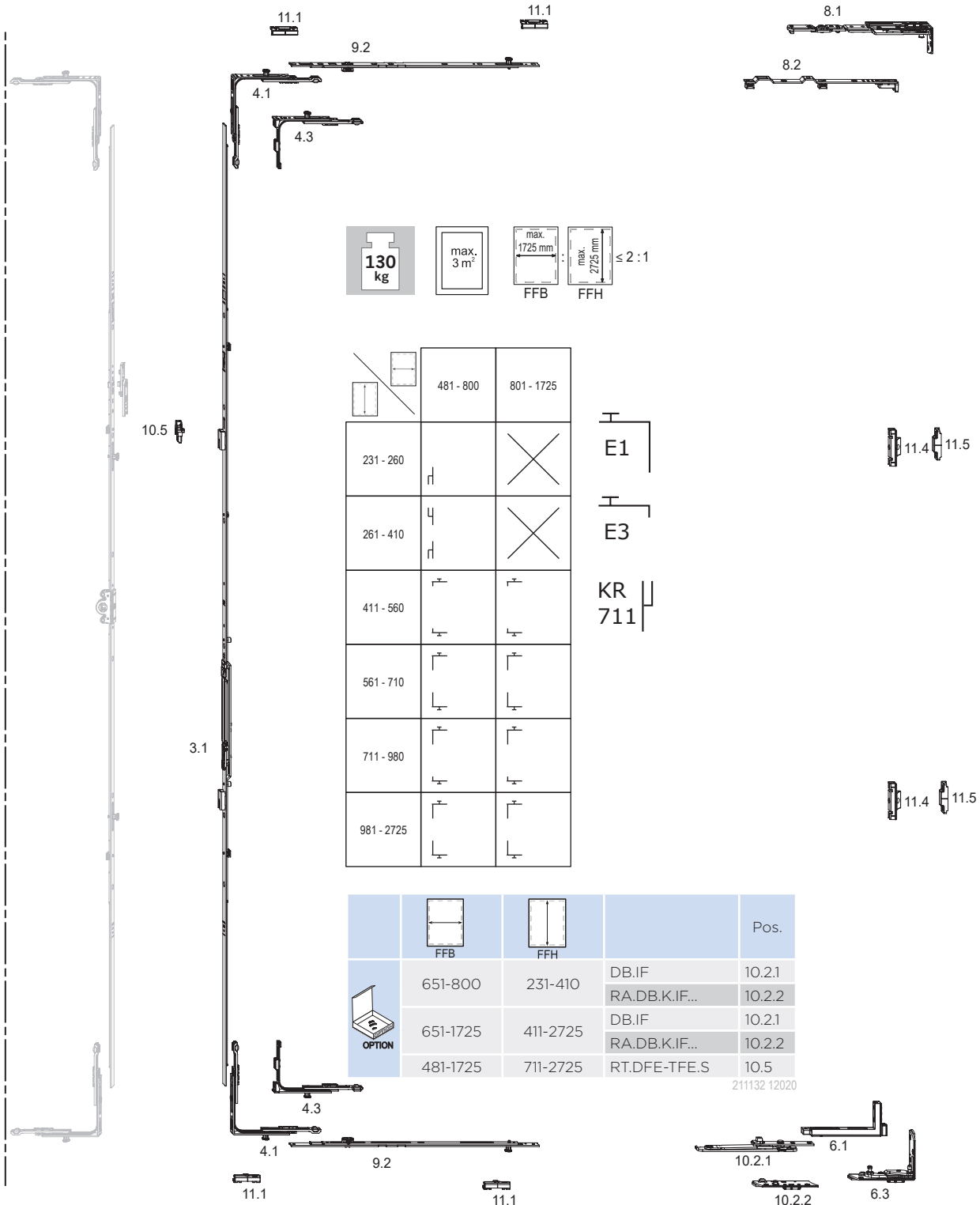







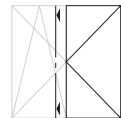
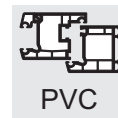





The shown distance between locking points is 800 mm.
 The locking distances must be agreed with the system provider.

Turn double-sash fitting – central handle position

Basic equipment with claw bolt



				Pos.		Pos.		Pos.		Pos.		
	481-1420	411-710	GASM.800	3.1								
	481-1725	711-980	GASM.1050-1.E3	3.1								
		981-1400	GASM.1400-1	3.1								
		1401-1800	GASM.1800-2	3.1								
		1801-2300	GASM.2300-3	3.1								
		2301-2725	GASM.2300-3	3.1	MS.SU.250-1	9.3	MS.SO.250-1	9.3				
	481-800	261-410	KR F 711.C...	10.10					SA...	11.6	1x	
	481-1120	411-560	E3	4.3					SBA.K...	11.1	1x	
	481-1725	561-2725	E1	4.1					SBA.K...	11.1	1x	
	841-1250	411-2725	M.500-1	9.2					SBA.K...	11.1	1x	
	1251-1500		M.750-1	9.2					SBA.K...	11.1	1x	
	1501-1725	MK.500-1	9.1	M.500-1	9.2				SBA.K...	11.1	2x	
		481-1725	231-2725	DL.K.IF-N...	8.1	DLS.IF...	8.2					
	481-1725	801-1600	ZV-FT SL	11.4					ZV-RT...	11.5	1x	
		1601-2400	ZV-FT SL	11.4	ZV-FT SL	11.4			ZV-RT...	11.5	2x	
		2401-2725	ZV-FT SL	11.4	ZV-FT SL	11.4	ZV-FT SL	11.4		ZV-RT...	11.5	3x
	481-800	231-410	FL.IF-N...	6.1	EL.K.IF-N...	6.3						
	481-1725	411-2725	FL.IF-N...	6.1	EL.K.IF-N...	6.3						
	841-1250	411-2725	M.500-1	9.2					SBA.K...	11.1	1x	
	1251-1500		M.750-1	9.2					SBA.K...	11.1	1x	
	1501-1725		MK.500-1	9.1	M.500-1	9.2				SBA.K...	11.1	2x
	481-800	231-410	KR F 711.C...	10.10					SA...	11.6	1x	
	481-1120	411-560	E3	4.3					SBA.K...	11.1	1x	
	481-1420	561-710	E1	4.1					SBA.K...	11.1	1x	
	481-1725	711-980	E3	4.3						SBA.K...	11.1	1x
		981-2725	E1	4.1						SBA.K...	11.1	1x

 marks a line with items that are always used, regardless of size

Turn double sash fitting – constant handle position

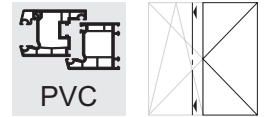

2

Suitable for burglary-resistant windows RC2 / RC2 N

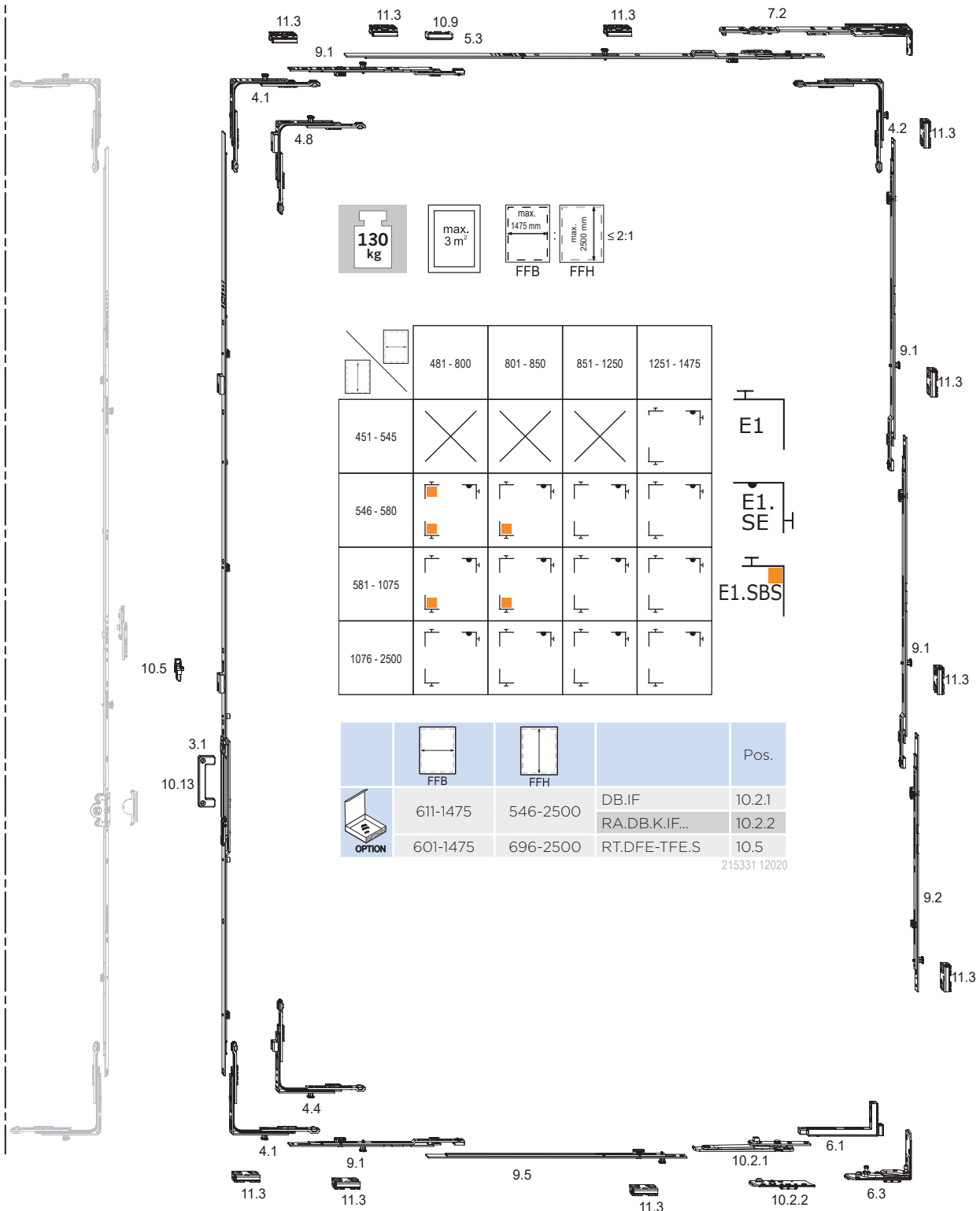

The shown distance between locking points is 800 mm.
The locking distances must be agreed with the system provider.

Turn double sash fitting - constant handle position

Suitable for burglary-resistant windows RC2 / RC2 N

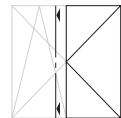
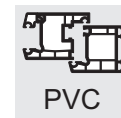

				Pos.		Pos.		Pos.		Pos.		
	601-1475	546-2500	SNH.AGR	10.13								
	601-1160	546-580	GASK.710	3.1								
	601-1390	581-695	GASK.830-1	3.1								
	601-1475	696-850	GASK.945-1	3.1								
		851-1075	GASK.1100-1	3.1								
		1076-1325	GASK.1325-2	3.1								
		1326-1525	GASK.1550-2	3.1								
		1526-1775	GASK.1775-2	3.1								
		1776-2000	GASK.2000-2	3.1								
		2001-2225	GASK.2225-2	3.1								
2226-2475	GASK.2225-2	3.1	MS.SO.250-1	9.3								
2476-2500	GASK.2225-2	3.1	MS.SO.500-1	9.3								
	601-800	546-580	E1.SBS.O	4.8					SBS.K...	11.3	1x	
	601-1475	581-2500	E1	4.1					SBS.K...	11.3	1x	
	801-1160	546-580	E1	4.1					SBS.K...	11.3	1x	
	601-1475	546-2500	AL D...	10.9								
	601-800		OS.SE.800	5.3								
	801-1025		OS.SE.1025-1	5.3						SBS.K...	11.3	1x
	1026-1275		OS.SE.1025-1	5.3	MK.250-1	9.1				SBS.K...	11.3	2x
	1276-1475		OS.SE.1025-1	5.3	MK.250-0	9.1	MK.250-1	9.1		SBS.K...	11.3	2x
	601-1475	546-2500	E1.SE	4.2	SK.IF-N...	7.2			SBS.K...	11.3	1x	
	601-1170	546-585	M.250-1	9.2					SBS.K...	11.3	1x	
	601-1475	586-1000	M.500-1	9.2					SBS.K...	11.3	1x	
		1001-1200	M.750-1	9.2					SBS.K...	11.3	1x	
		1201-1550	MK.500-1	9.1	M.500-1	9.2			SBS.K...	11.3	2x	
		1551-1720	MK.750-1	9.1	M.500-1	9.2			SBS.K...	11.3	2x	
		1721-1970	MK.500-1	9.1	MK.500-1	9.1	M.500-1	9.2		SBS.K...	11.3	3x
		1971-2220	MK.750-1	9.1	MK.500-1	9.1	M.500-1	9.2		SBS.K...	11.3	3x
		2221-2470	MK.750-1	9.1	MK.750-1	9.1	M.500-1	9.2		SBS.K...	11.3	3x
2471-2500	MK.750-1	9.1	MK.500-1	9.1	MK.500-1	9.1		SBS.K...	11.3	4x		
		M.500-1	9.2									
	601-1475	546-2500	FL.IF-N...	6.1	EL.K.IF-N...	6.3						
	601-850	546-2500	V.AK.450-1	9.5					SBS.K...	11.3	1x	
	851-1100		V.AK.450-1	9.5	MK.250-1	9.1			SBS.K...	11.3	2x	
	1101-1360		V.AK.450-1	9.5	MK.500-1	9.1			SBS.K...	11.3	2x	
	1361-1475		V.AK.450-1	9.5	MK.750-1	9.1			SBS.K...	11.3	2x	
	601-850	546-1075	E1.SBS.U	4.4					SBS.K...	11.3	1x	
	601-1475	1076-2500	E1	4.1					SBS.K...	11.3	1x	
	851-1475	546-1075	E1	4.1					SBS.K...	11.3	1x	

marks a line with items that are always used, regardless of size

Turn double-sash fitting - central handle position

Suitable for burglary-resistant windows RC2 / RC2 N

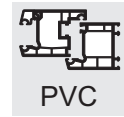

2



130 kg

max. 3 m²

max. 1475 mm FFB

max. 2500 mm FFH

≤ 2:1

		481 - 800	801 - 850	851 - 1250	1251 - 1475	
		X	X	X		E1
		■	■			E1. SE
		■	■			E3
						E1.SBS

	FFB	FFH		Pos.
	611-1475	546-2500	DB.IF	10.2.1
			RA.DB.K.IF...	10.2.2
OPTION	601-1475	711-2500	RT.DFE-TFE.S	10.5









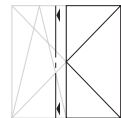
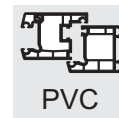



215131 12020

The shown distance between locking points is 800 mm.
The locking distances must be agreed with the system provider.

Turn double-sash fitting – central handle position

Suitable for burglary-resistant windows RC2 / RC2 N



				Pos.		Pos.		Pos.		Pos.	
	 601-1475	546-2500	SNH.AGR	10.13							
	601-1160	546-580	GASK.710	3.1							
	601-1420	581-710	GASK.830-1	3.1							
	601-1475	711-980	GASM.1050-1.E3	3.1							
		981-1400	GASM.1400-2	3.1							
		1401-1800	GASM.1800-2	3.1							
		1801-2300	GASM.2300-3	3.1							
	2301-2500	GASM.1800-2	3.1	MS.SU.500-1	9.3	MS.SO.500-1	9.3				
	601-800	546-580	E1.SBS.O	4.8				SBS.K...	11.3	1x	
	601-1475	581-2500	E1	4.1				SBS.K...	11.3	1x	
	801-1160	546-580	E1	4.1				SBS.K...	11.3	1x	
	 601-1475	546-2500	AL D...	10.9							
	601-800		OS.SE.800	5.3							
	801-1025		OS.SE.1025-1	5.3				SBS.K...	11.3	1x	
	1026-1275		OS.SE.1025-1	5.3	MK.250-1	9.1		SBS.K...	11.3	2x	
	1276-1475		OS.SE.1025-1	5.3	MK.250-0	9.1	MK.250-1	9.1	SBS.K...	11.3	2x
	601-1475	546-2500	E1.SE	4.2	SK.IF-N...	7.2		SBS.K...	11.3	1x	
	601-1170	546-585	M.250-1	9.2				SBS.K...	11.3	1x	
	601-1475	586-1000	M.500-1	9.2				SBS.K...	11.3	1x	
		1001-1200	M.750-1	9.2				SBS.K...	11.3	1x	
		1201-1550	MK.500-1	9.1	M.500-1	9.2		SBS.K...	11.3	2x	
		1551-1720	MK.750-1	9.1	M.500-1	9.2		SBS.K...	11.3	2x	
		1721-1970	MK.500-1	9.1	MK.500-1	9.1	M.500-1	9.2	SBS.K...	11.3	3x
		1971-2220	MK.750-1	9.1	MK.500-1	9.1	M.500-1	9.2	SBS.K...	11.3	3x
		2221-2470	MK.750-1	9.1	MK.750-1	9.1	M.500-1	9.2	SBS.K...	11.3	3x
2471-2500	MK.750-1	9.1	MK.500-1	9.1	MK.500-1	9.1	SBS.K...	11.3	4x		
		M.500-1	9.2								
	601-1475	546-2500	FL.IF-N...	6.1	EL.K.IF-N...	6.3					
	601-850	546-2500	V.AK.450-1	9.5				SBS.K...	11.3	1x	
	851-1100		V.AK.450-1	9.5	MK.250-1	9.1		SBS.K...	11.3	2x	
	1101-1360		V.AK.450-1	9.5	MK.500-1	9.1		SBS.K...	11.3	2x	
	1361-1475		V.AK.450-1	9.5	MK.750-1	9.1		SBS.K...	11.3	2x	
	601-850	546-710	E1.SBS.U	4.4				SBS.K...	11.3	1x	
	601-1475	711-980	E3	4.3				SBS.K...	11.3	1x	
		981-2500	E1	4.1				SBS.K...	11.3	1x	
		851-1420	546-710	E1	4.1				SBS.K...	11.3	1x

 marks a line with items that are always used, regardless of size

2

Turn-tilt fitting – constant handle position

Basic equipment for triple-sash elements

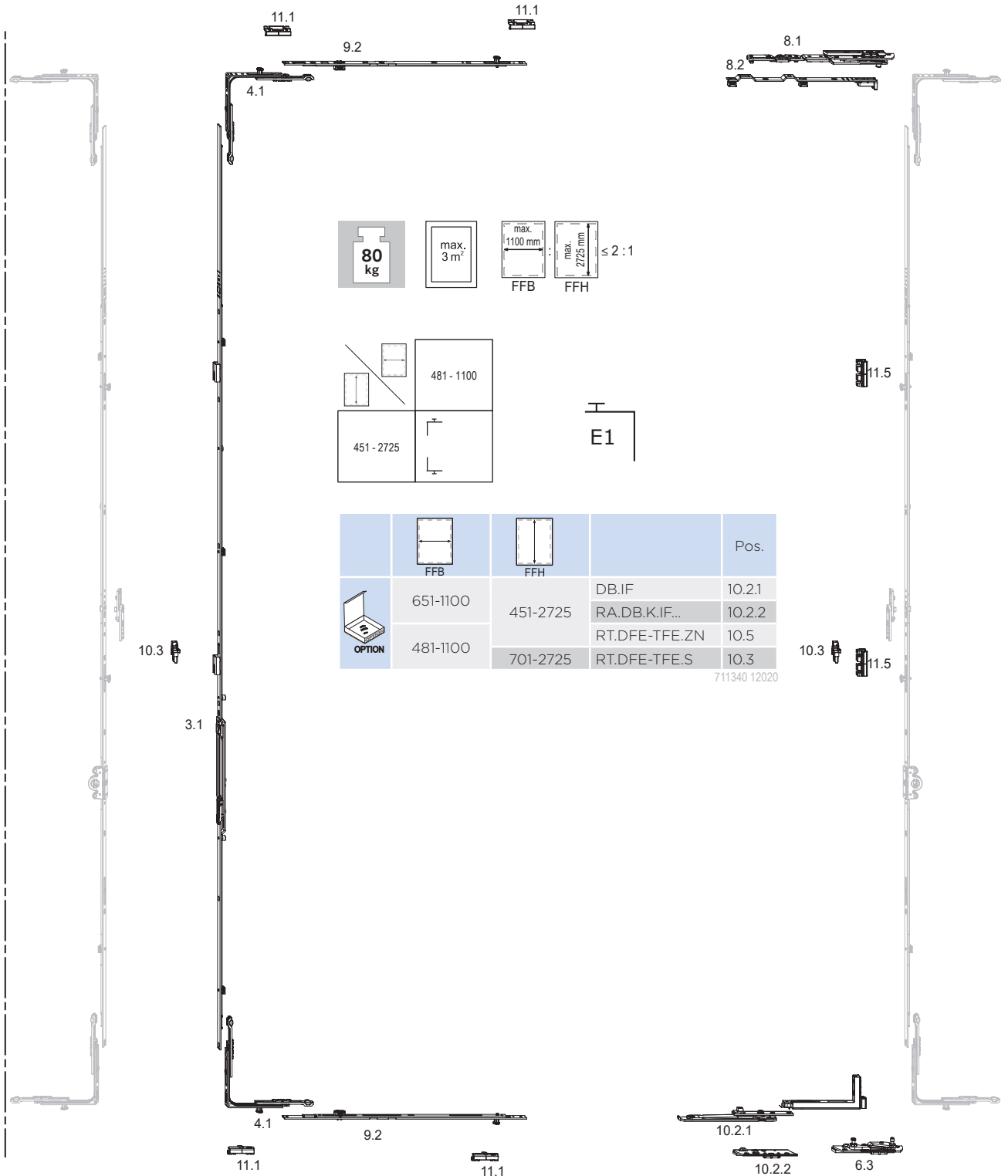
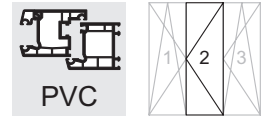







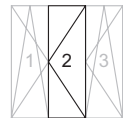
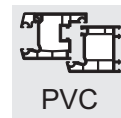



The shown distance between locking points is 800 mm.
 The locking distances must be agreed with the system provider.

Turn-tilt fitting – constant handle position

Basic equipment for triple-sash elements



				Pos.		Pos.		Pos.		Pos.	
	481-1100	451-700	GASK.710	3.1			GK = 210				
		701-850	GASK.945-1	3.1			GK = 260				
		851-1100	GASK.1100-1	3.1			GK = 375				
		1101-1325	GASK.1325-1	3.1			GK = 550				
		1326-1550	GASK.1550-1	3.1			GK = 550				
		1551-1775	GASK.1775-2	3.1			GK = 550				
		1776-2000	GASK.2000-2	3.1			GK = 1050				
		2001-2225	GASK.2225-2	3.1			GK = 1050				
		2226-2475	GASK.2225-2	3.1	MS.SO.250-1	9.3		GK = 1050			
2476-2725	GASK.2225-2	3.1	MS.SO.500-1	9.3		GK = 1050					
	481-1100	451-2725	E1	4.1					SBA.K...	11.1	1x
	841-1100	451-2725	M.500-1	9.2					SBA.K...	11.1	1x
	481-1100	451-2725	DLS.IF...	8.2							
			DL.K.IF-N.3...	8.1							
	481-1100	581-1550							SBA.K.BN	11.5	1x
		1551-2225							SBA.K.BN	11.5	2x
		2226-2725							SBA.K.BN	11.5	3x
	481-1100	451-2725	FL.IF-N...	6.1	EL.K.IF-N.3...	6.3					
	841-1100	451-2725	M.500-1	9.2					SBA.K...	11.1	1x
	481-1100	451-2725	E1	4.1					SBA.K...	11.1	1x

 marks a line with items that are always used, regardless of size

2

Turn-tilt fitting - central handle position Basic equipment for triple-sash elements

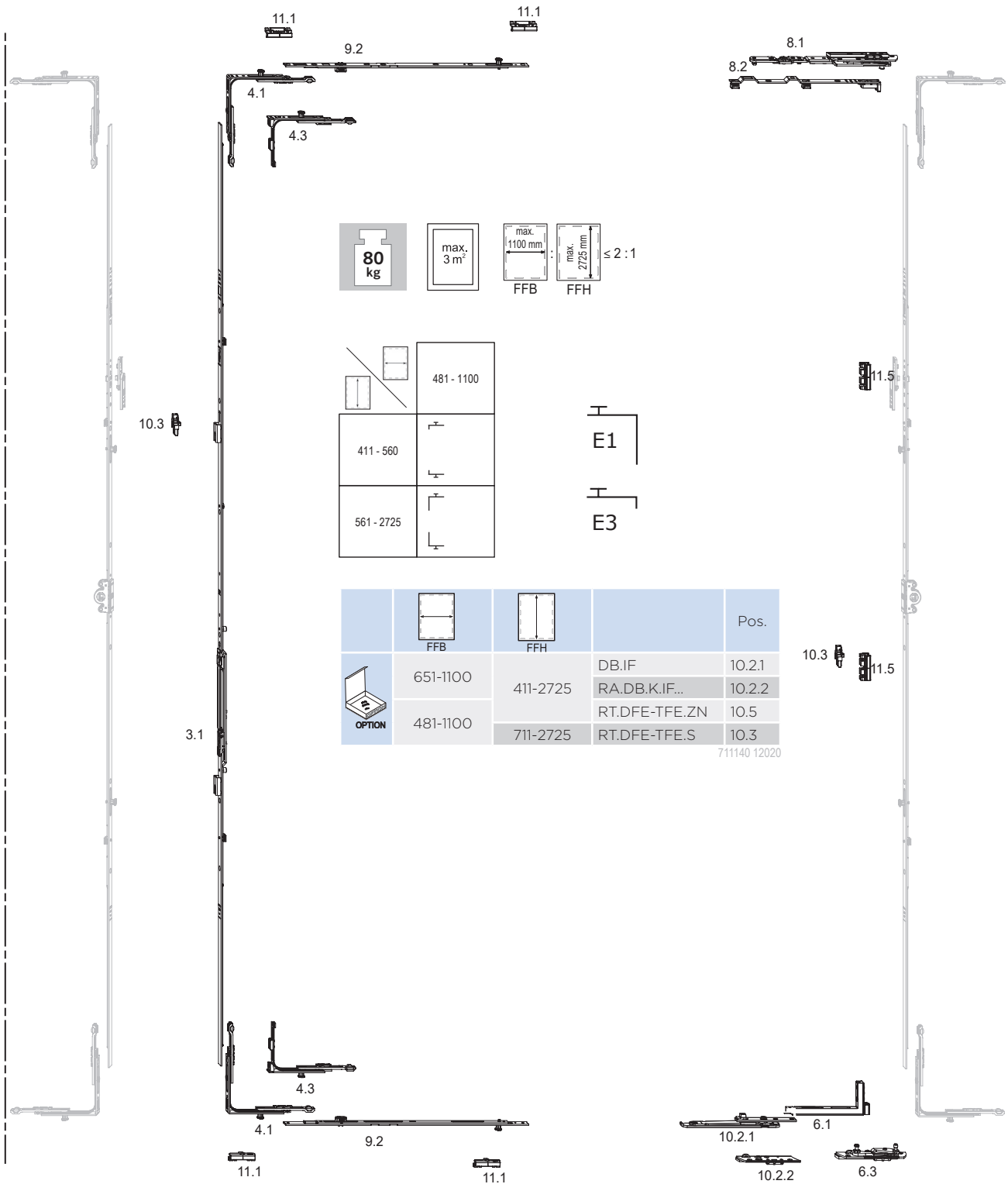
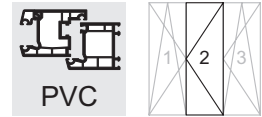

80 kg max. 3 m² max. 1100 mm FFB max. 2725 mm FFH ≤ 2 : 1

		481 - 1100
		411 - 560
		561 - 2725

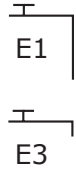

	FFB	FFH		Pos.
	651-1100	411-2725	DB.IF	10.2.1
			RA.DB.K.IF...	10.2.2
	481-1100	711-2725	RT.DFE-TFE.ZN	10.5
			RT.DFE-TFE.S	10.3









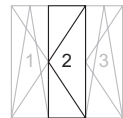
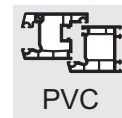

711140 12020

The shown distance between locking points is 800 mm.
The locking distances must be agreed with the system provider.

Turn-tilt fitting – central handle position

Basic equipment for triple-sash elements



				Pos.		Pos.		Pos.		Pos.	
	481-1100	411-710	GASM.800	3.1							
		711-980	GASM.1050-1.E3	3.1							
		981-1400	GASM.1400-1	3.1							
		1401-1800	GASM.1800-2	3.1							
		1801-2300	GASM.2300-3	3.1							
		2301-2725	GASM.2300-3	3.1	MS.SU.250-1	9.3	MS.SO.250-1	9.3			
	481-1100	411-560	E3	4.3					SBA.K...	11.1	1x
		561-2725	E1	4.1					SBA.K...	11.1	1x
	841-1100	411-2725	M.500-1	9.2					SBA.K...	11.1	1x
	481-1100	411-2725	DLS.IF...	8.2							
			DL.K.IF-N.3...	8.1							
	481-1100	981-1400							SBA.K.BN	11.5	1x
		1401-1800							SBA.K.BN	11.5	2x
		1801-2300							SBA.K.BN	11.5	3x
		2301-2725							SBA.K.BN	11.5	5x
	481-1100	411-2725	FL.IF-N...	6.1	EL.K.IF-N.3...	6.3					
	841-1100	411-2725	M.500-1	9.2					SBA.K...	11.1	1x
	481-1100	411-560	E3	4.3					SBA.K...	11.1	1x
		561-2725	E1	4.1					SBA.K...	11.1	1x

 marks a line with items that are always used, regardless of size

Turn-tilt fitting – constant handle position

Basic equipment – Tilt before turn

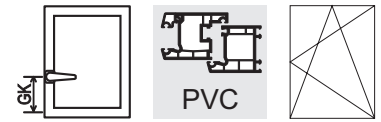

2

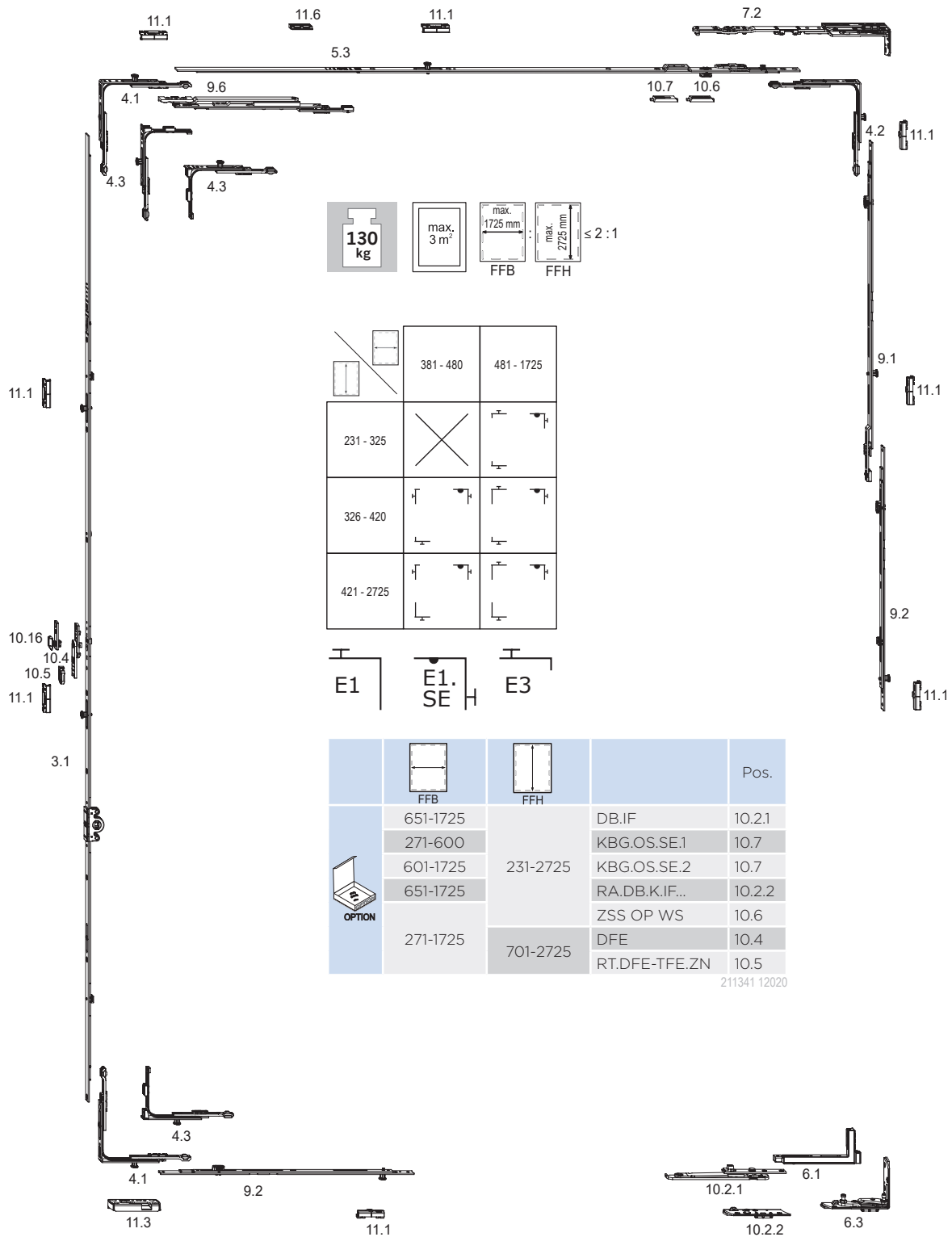







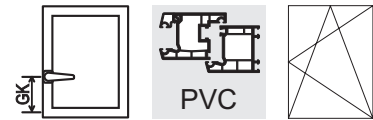



The shown distance between locking points is 800 mm.
 The locking distances must be agreed with the system provider.

Turn-tilt fitting – constant handle position

Basic equipment – Tilt before turn



				Pos.		Pos.		Pos.		Pos.		
	481-650	231-325	GAK.465	3.1			GK = 114					
	381-840	326-420	GAK.465	3.1			GK = 114					
	381-920	421-460	GAK.465	3.1			GK = 210					
	381-1400	461-700	GAK.710	3.1			GK = 210					
	381-1700	701-850	GAK.945-1	3.1	FSF	10.16	GK = 260		SBA.K...	11.1	1x	
	381-1725	851-1100	GAK.1100-1	3.1	FSF	10.16	GK = 375		SBA.K...	11.1	1x	
		1101-1325	GAK.1325-1	3.1	FSF	10.16	GK = 550		SBA.K...	11.1	1x	
		1326-1550	GAK.1550-1	3.1	FSF	10.16	GK = 550		SBA.K...	11.1	1x	
		1551-1775	GAK.1775-2	3.1	FSF	10.16	GK = 550		SBA.K...	11.1	2x	
		1776-2000	GAK.2000-2	3.1	FSF	10.16	GK = 1050		SBA.K...	11.1	2x	
2001-2225		GAK.2225-2	3.1	FSF	10.16	GK = 1050		SBA.K...	11.1	2x		
2226-2475		GAK.2225-2 MK.250-1	3.1 9.1	FSF	10.16	GK = 1050		SBA.K...	11.1	3x		
2476-2725	GAK.2225-2 MK.500-1	3.1 9.1	FSF	10.16	GK = 1050		SBA.K...	11.1	3x			
	381-480	326-2725	E3	4.3					SBA.K...	11.1	1x	
	481-650	231-325	E3	4.3					SBA.K...	11.1	1x	
	481-1725	326-2725	E1	4.1					SBA.K...	11.1	1x	
	381-550	326-2725	OS.SE.550.E	5.3								
	481-550	231-325	OS.SE.550.E	5.3								
	551-800	231-2725	OS.SE.800.E	5.3								
	801-1025		OS.SE.1025-1.E	5.3					SBA.K...	11.1	1x	
	1026-1250		OS.SE.1250-1.E	5.3						SBA.K...	11.1	1x
	1251-1475		OS.SE.1250-1.E	5.3	MK.250-0	9.1				SBA.K...	11.1	1x
	1476-1500		OS.SE.1025-1.E	5.3	MK.250-1	9.1	FT WSK...	11.6		SBA.K...	11.1	2x
ZSRE SL			9.6									
1501-1725	OS.SE.1250-1.E		5.3	MK.250-1	9.1	FT WSK...	11.6		SBA.K...	11.1	2x	
ZSRE SL	9.6											
	381-1725	326-2725	E1.SE	4.2	SK.IF-N.E...	7.2			SBA.K...	11.1	1x	
	481-650	231-325	E1.SE	4.2	SK.IF-N.E...	7.2			SBA.K...	11.1	1x	
	381-1725	861-1285	M.500-1	9.2					SBA.K...	11.1	1x	
		1286-1535	M.750-1	9.2					SBA.K...	11.1	1x	
		1536-1785	MK.500-1	9.1	M.500-1	9.2			SBA.K...	11.1	2x	
		1786-2035	MK.750-1	9.1	M.500-1	9.2			SBA.K...	11.1	2x	
		2036-2285	MK.750-1	9.1	M.750-1	9.2			SBA.K...	11.1	2x	
		2286-2535	MK.750-1	9.1	MK.500-1	9.1	M.500-1	9.2		SBA.K...	11.1	3x
2536-2725	MK.750-1	9.1	MK.750-1	9.1	M.500-1	9.2		SBA.K...	11.1	3x		
	481-650	231-325	FL.IF-N...	6.1	EL.K.IF-N...	6.3						
	381-1725	326-2725	FL.IF-N...	6.1	EL.K.IF-N...	6.3						
	841-1250	231-2725	M.500-1	9.2					SBA.K...	11.1	1x	
	1251-1500		M.750-1	9.2					SBA.K...	11.1	1x	
	1501-1725		MK.500-1	9.1	M.500-1	9.2			SBA.K...	11.1	2x	
	381-840	326-420	E3	4.3					SBS.K.PAD...	11.3	1x	
	381-1725	421-2725	E1	4.1					SBS.K.PAD...	11.3	1x	
	481-650	231-325	E3	4.3					SBS.K.PAD...	11.3	1x	

In case of sash rebate heights (FFH) of < 701 mm it is not possible to install a fail-safe device directly onto the drive rod. By combining a shorter drive rod with an MK.250.FSF interlocking rod, the required fail-safe device can be integrated from a sash rebate height of > 475 mm.

 marks a line with items that are always used, regardless of size

Turn-tilt fitting – central handle position

Basic equipment – Tilt before turn

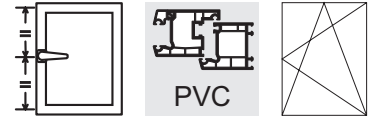

2

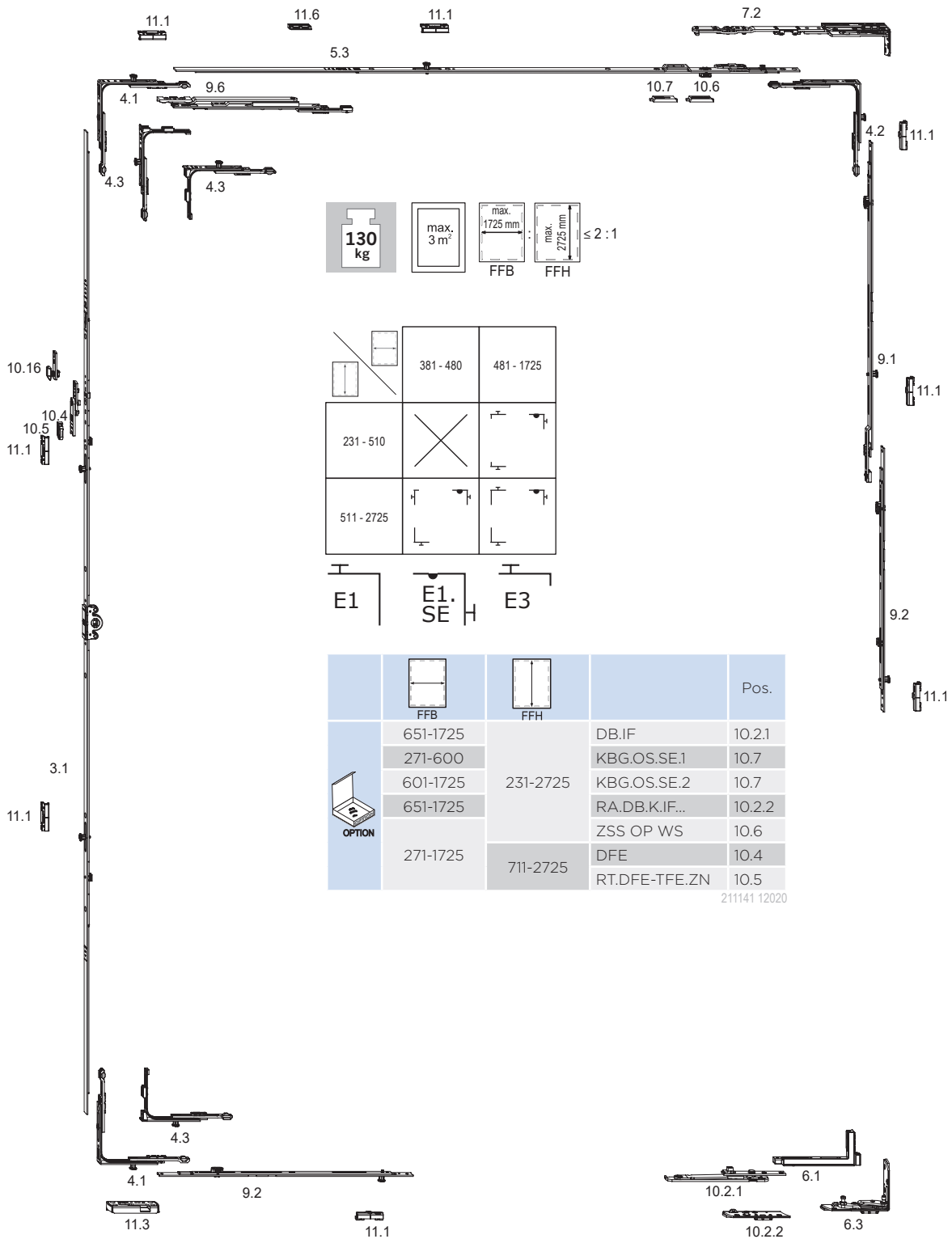

The shown distance between locking points is 800 mm.
The locking distances must be agreed with the system provider.

Turn-tilt fitting – central handle position

Basic equipment – Tilt before turn

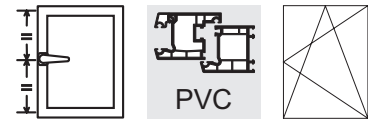

				Pos.		Pos.		Pos.		Pos.	
	481-650	231-325	GAK.465	3.1			GK = 114				
	481-1020	326-510	GAM.800	3.1							
	381-1420	511-710	GAM.800	3.1							
	381-1725	711-980	GAM.1050-1	3.1	FSF	10.16			SBA.K...	11.1	1x
		981-1400	GAM.1400-1	3.1	FSF	10.16			SBA.K...	11.1	1x
		1401-1800	GAM.1800-2	3.1	FSF	10.16			SBA.K...	11.1	2x
1801-2300		GAM.2300-3	3.1	FSF	10.16			SBA.K...	11.1	3x	
2301-2725	GAM.2300-3 MK.250-1	3.1 9.1	FSF	10.16	MK.250-1	9.1	SBA.K...	11.1	5x		
	381-480	511-2725	E3	4.3				SBA.K...	11.1	1x	
	481-1020	231-510	E3	4.3				SBA.K...	11.1	1x	
	481-1725	511-2725	E1	4.1				SBA.K...	11.1	1x	
	381-550	511-2725	OS.SE.550.E	5.3							
	481-550	231-510	OS.SE.550.E	5.3							
	551-800	231-2725	OS.SE.800.E	5.3							
	801-1025		OS.SE.1025-1.E	5.3				SBA.K...	11.1	1x	
	1026-1250		OS.SE.1250-1.E	5.3					SBA.K...	11.1	1x
	1251-1475		OS.SE.1250-1.E	5.3	MK.250-0	9.1			SBA.K...	11.1	1x
	1476-1500		OS.SE.1025-1.E	5.3	MK.250-1	9.1	FT WSK...	11.6	SBA.K...	11.1	2x
ZSRE SL			9.6								
1501-1725	OS.SE.1250-1.E		5.3	MK.250-1	9.1	FT WSK...	11.6	SBA.K...	11.1	2x	
ZSRE SL	9.6										
	381-1725	511-2725	E1.SE	4.2	SK.IF-N.E...	7.2		SBA.K...	11.1	1x	
	481-1020	231-510	E1.SE	4.2	SK.IF-N.E...	7.2		SBA.K...	11.1	1x	
	381-1725	861-1285	M.500-1	9.2				SBA.K...	11.1	1x	
		1286-1535	M.750-1	9.2				SBA.K...	11.1	1x	
		1536-1785	MK.500-1	9.1	M.500-1	9.2			SBA.K...	11.1	2x
		1786-2035	MK.750-1	9.1	M.500-1	9.2			SBA.K...	11.1	2x
		2036-2285	MK.750-1	9.1	M.750-1	9.2			SBA.K...	11.1	2x
		2286-2535	MK.750-1	9.1	MK.500-1	9.1	M.500-1	9.2	SBA.K...	11.1	3x
2536-2725	MK.750-1	9.1	MK.750-1	9.1	M.500-1	9.2	SBA.K...	11.1	3x		
	481-1020	231-510	FL.IF-N...	6.1	EL.K.IF-N...	6.3					
	381-1725	511-2725	FL.IF-N...	6.1	EL.K.IF-N...	6.3					
	841-1250	231-2725	M.500-1	9.2				SBA.K...	11.1	1x	
	1251-1500		M.750-1	9.2				SBA.K...	11.1	1x	
	1501-1725		MK.500-1	9.1	M.500-1	9.2			SBA.K...	11.1	2x
	381-1725	511-2725	E1	4.1				SBS.K.PAD...	11.3	1x	
	481-1020	231-510	E3	4.3				SBS.K.PAD...	11.3	1x	

In case of sash rebate heights (FFH) of < 711 mm it is not possible to install a fail-safe device directly onto the drive rod. By combining a shorter drive rod with an MK.250.FSF interlocking rod, the required fail-safe device can be integrated from a sash rebate height of > 475 mm.

marks a line with items that are always used, regardless of size

Tilt fanlight

Basic equipment

2

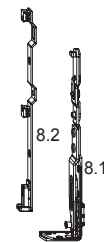
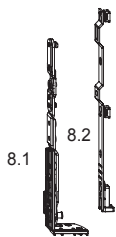
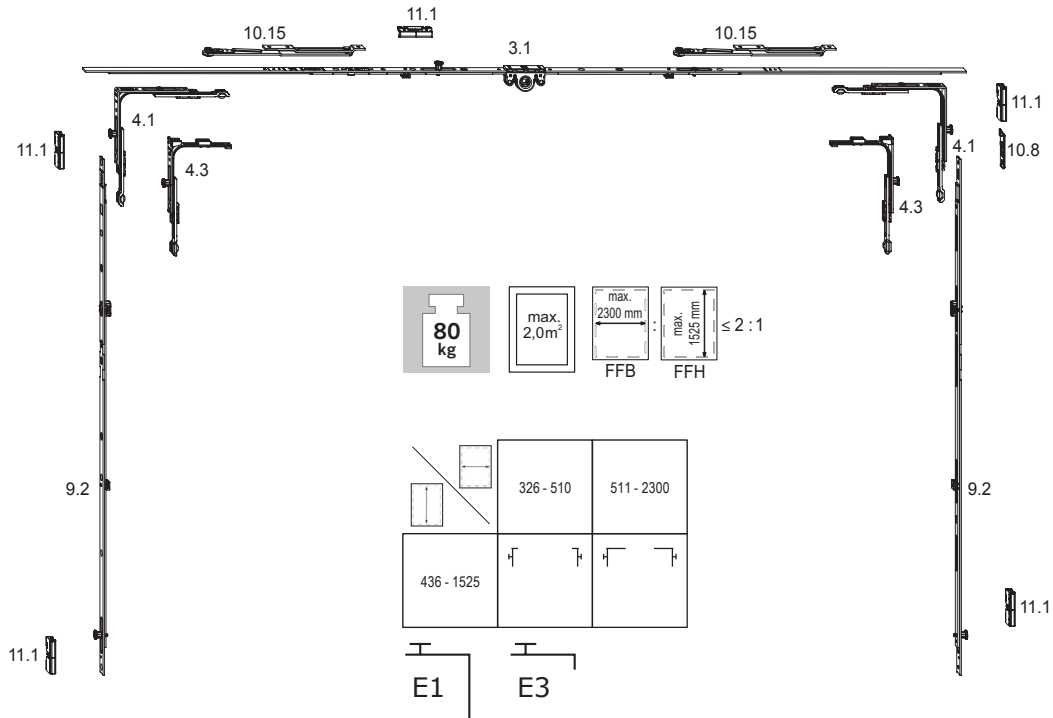
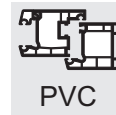







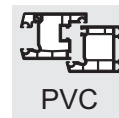



The shown distance between locking points is 800 mm.
 The locking distances must be agreed with the system provider.

Tilt fanlight

Basic equipment



				Pos.		Pos.		Pos.		Pos.	
	326-710	191-1525	GAM.800	3.1	GRT FSR SL	10.15					
	711-1050		GAM.1050-1	3.1	GRT FSR SL	10.15			SBA.K...	11.1	1x
	1051-1400		GAM.1400-1	3.1	GRT FSR SL	10.15	GRT FSR SL	10.15	SBA.K...	11.1	1x
	1401-1800		GAM.1800-2	3.1	GRT FSR SL	10.15	GRT FSR SL	10.15	SBA.K...	11.1	2x
	1801-2300		GAM.2300-3	3.1	GRT FSR SL	10.15	GRT FSR SL	10.15	SBA.K...	11.1	3x
	326-510	191-1525	E3	4.3					SBA.K...	11.1	1x
	511-2300		E1	4.1					SBA.K...	11.1	1x
	326-2300	 191-1525	DL.K.IF-N...LS	8.1	DLS.IF...	8.2					
		861-1285	M.500-1	9.2					SBA.K...	11.1	1x
		1286-1525	M.750-1	9.2					SBA.K...	11.1	1x
	741-1480	191-1525	ZV-FT SL	11.4					ZV-RT...	11.5	1x
	1481-2300		ZV-FT SL	11.4	ZV-FT SL	11.4			ZV-RT...	11.5	2x
	326-2300	 191-1525	DL.K.IF-N...RS	8.1	DLS.IF...	8.2					
		861-1285	M.500-1	9.2					SBA.K...	11.1	1x
		1286-1525	M.750-1	9.2					SBA.K...	11.1	1x
	 326-2300	191-1525	AWDR SL	10.8							
	326-510		E3	4.3					SBA.K...	11.1	1x
	511-2300		E1	4.1					SBA.K...	11.1	1x

211151 12020

- To secure the tilting sash in 90° opening position, or during cleaning, the window must also be fitted with standard cleaning or supporting shears.
- The sashes must be secured in cleaning position to prevent excessive force acting on the hinges.
- After cleaning the window, the rebate shear must be properly mounted and secured.
- Close windows in case of wind and draft. Move the fitting to locking position

 marks a line with items that are always used, regardless of size

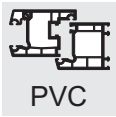

PVC

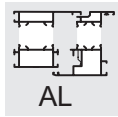

AL

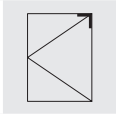
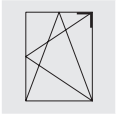

4

Corner drive E1.SE.N

- Utilisation in combination with the shears
SH.SE / SA.SE / SK.SE and SH.IF / SA.IF / SK.IF
- Bracket length 98.5 mm
- Automatic and manual assembly possible
- Smooth operation, due to rust-free spring steel hinges inserted in C-rail
- With supporting element to fix in the fitting groove of the sash

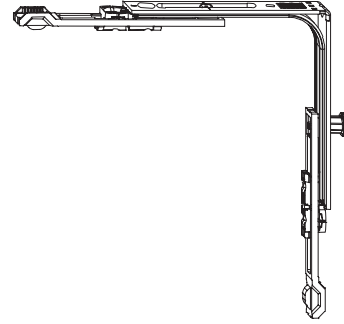

E1.SE.N

Item designation	Item no.		VPA1 Pcs/type	VPA2 Pcs/type
E1.SE.N	5060652	4	100 KK	2400 EK

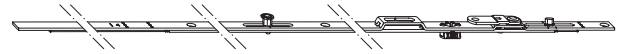
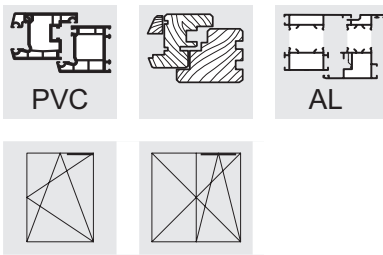

Top rod OS.SE

- In combination with shears S...SE / S...IF / S...IF-N
- After assembly the top rod and the shear are firmly attached to one another
- From 1475 mm sash rebate width with additional shear ZSR
- Clampable in fitting groove

Top rod OS.SE...E

- For the type of fitting "Tilt before turn"
- In combination with shears S...SE.E / S...IF.E / S...IF-N.E
- From 1475 mm sash rebate width with additional shear ZSRE
- Other details regarding the design see above

Item designation	Item no.	Application range		VPA1 Pcs/type	VPA2 Pcs/type
OS.SE.550	4934243	FFB 480 - 550	3	20 BD	800 EA
OS.SE.800	4934244	FFB 550 - 800	4	20 BD	800 EA
OS.SE.1025-1	4934245	FFB 775 - 1025	5	20 BD	500 EA
OS.SE.1250-1	4934246	FFB 1000 - 1250	6	20 BD	500 EA
OS.SE.550.E	5003250	FFB 480 - 550	3	20 BD	800 EA
OS.SE.800.E	5003251	FFB 550 - 800	4	20 BD	800 EA
OS.SE.1025-1.E	5003252	FFB 775 - 1025	5	20 BD	500 EA
OS.SE.1250-1.E	5003253	FFB 1000 - 1250	6	20 BD	500 EA

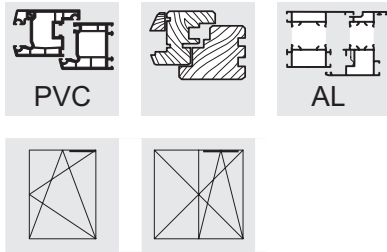

5

Top rod OS.SE...E1.SE.F

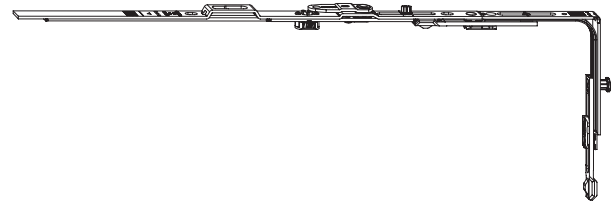

- Top rod OS.SE... with pre-connected E1.SE for efficient assembly by means of screwing machines
- In combination with shears S...SE / S...IF / S...IF-N
- After assembly the top rod and the shear are firmly attached to one another
- From 1475 mm sash rebate width with additional shear ZSR

Top rod OS.SE...E1.ZSS

- With pre-assembled anti-slam device

Top rod OS.SE...E.ZSS.E1.SE.F

- For the type of fitting "Tilt before turn"
- With pre-assembled anti-slam device
- In combination with shears S...SE.E / S...IF.E / S...IF-N.E
- From 1475 mm sash rebate width with additional shear ZSRE

Item designation	Item no.	Application range		VPA1 Pcs/type	VPA2 Pcs/type
OS.SE.550.E1.SE.F	4942498	FFB 480 - 550	5	10 BD	400 EA
OS.SE.800.E1.SE.F	4942499	FFB 550 - 800	5	10 BD	400 EA
OS.SE.1025-1.E1.SE.F	4942500	FFB 775 - 1025	6	10 BD	400 EA
OS.SE.1250-1.E1.SE.F	4942501	FFB 1000 - 1250	6	10 BD	400 L1
OS.SE.550.E1.ZSS	5025778	FFB 480 - 550	5	10 BD	400 EA
OS.SE.800.E1.ZSS	5025779	FFB 550 - 800	5	10 BD	400 EA
OS.SE.1025-1.E1.ZSS	5025780	FFB 775 - 1025	6	10 BD	400 EA
OS.SE.1250-1.E1.ZSS	5025781	FFB 1000 - 1250	6	10 BD	400 L1
OS.SE.550.E.ZSS.E1.SE.F	5049407	FFB 480 - 550	5	10 BD	400 EA
OS.SE.800.E.ZSS.E1.SE.F	5049409	FFB 550 - 800	5	10 BD	400 EA
OS.SE.1025-1.E.ZSS.E1.SE.F	5049411	FFB 775 - 1025	6	10 BD	400 EA
OS.SE.1250-1.E.ZSS.E1.SE.F	5049412	FFB 1000 - 1250	6	10 BD	400 L1

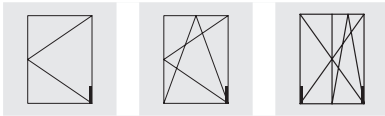
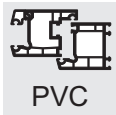

Corner hinges EL.K.IF-N

- In combination with sash hinge FL.IF-N
- Pressure adjustment: +/- 0.8 mm
- Sash weight max. 130 kg
- Max. Opening angle 95°
- Easy assembly thanks to profile adjustment

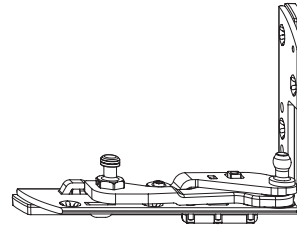

Note:

- Please observe the specifications concerning screw fixing of hinge parts that are given in the mounting instructions!
- The overview of profile allocation for the individual items is illustrated at the beginning of the chapter "Fittings lists".

Item designation	Item no.		Max. sash weight (kg)	VPA1 Pcs/type	VPA2 Pcs/type
EL.K.IF-N.128.RS	5100460	7	130	50 KK	400 EK
EL.K.IF-N.128.LS	5100461	7	130	50 KK	400 EK
EL.K.IF-N.152.RS	5100464	7	130	50 KK	400 EK
EL.K.IF-N.152.LS	5100519	7	130	50 KK	400 EK
EL.K.IF-N.161.RS	5100520	7	130	50 KK	400 EK
EL.K.IF-N.161.LS	5100521	7	130	50 KK	400 EK
EL.K.IF-N.162.RS	5100456	7	130	50 KK	400 EK
EL.K.IF-N.162.LS	5100457	7	130	50 KK	400 EK
EL.K.IF-N.166.RS	5100452	7	130	50 KK	400 EK
EL.K.IF-N.166.LS	5100453	7	130	50 KK	400 EK
EL.K.IF-N.169.RS	5100450	7	130	50 KK	400 EK
EL.K.IF-N.169.LS	5100451	7	130	50 KK	400 EK
EL.K.IF-N.205.RS	5100458	7	130	50 KK	400 EK
EL.K.IF-N.205.LS	5100459	7	130	50 KK	400 EK
EL.K.IF-N.262.RS	5100462	7	130	50 KK	400 EK
EL.K.IF-N.262.LS	5100463	7	130	50 KK	400 EK

RS = right, LS = left

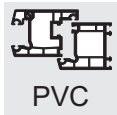

PVC

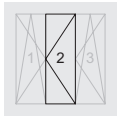

Corner hinges EL.K.IF-N.3

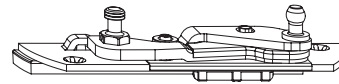

6

- Hinge component for the centre sash in 3-sash windows
- In combination with sash hinge FL.IF-N
- Installation on the frame
- Fully concealed when the sash is closed
- Max. Opening angle 95°
- Easy assembly thanks to profile adjustment

Note:

- Please observe the specifications concerning screw fixing of hinge parts that are given in the mounting instructions!
- The overview of individual Winkhaus items for profile systems is shown at the beginning of chapter 2 "Lists of fittings".

Item designation	Item no.		Max. sash weight (kg)	VPA1 Pcs/type	VPA2 Pcs/type
EL.K.IF-N.3.161.RS	5101757	5	80	50 KK	400 EK
EL.K.IF-N.3.161.LS	5101758	5	80	50 KK	400 EK

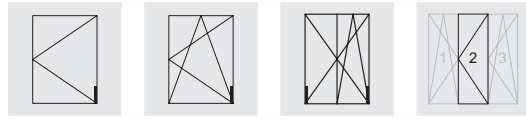
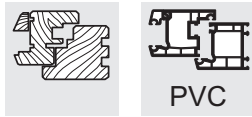

Sash hinges FL.IF-N

- Sash weight max. 130 kg
- Height adjustment +2 mm / -1.5 mm
- Side adjustment +2.5 mm / -2.5 mm
- Used in combination with corner hinge EL...IF-N

Sash hinge FL.IF-N.C

- As described above, but as clampable version for automatic screwing

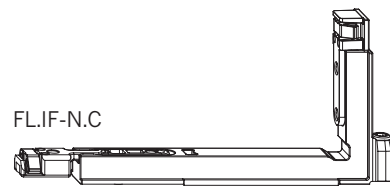

Item designation	Item no.		Groove centre position	Max. sash weight (kg)	VPA1 Pcs/type	VPA2 Pcs/type
FL.IF-N.RS	5100821	4	13 mm	130	50 KK	400 EK
FL.IF-N.LS	5100822	4	13 mm	130	50 KK	400 EK
FL.IF-N.C.RS	5100825	4	13 mm	130	50 KK	400 EK
FL.IF-N.C.LS	5100826	4	13 mm	130	50 KK	400 EK

RS = right, LS = left

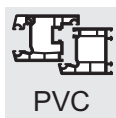

PVC

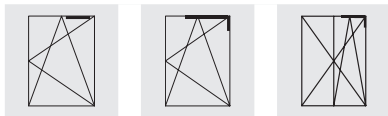

Shears SK.IF-N

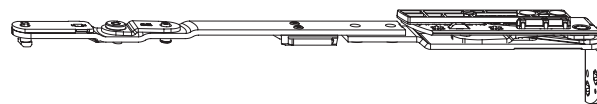

- When sash is closed, it is completely concealed with no hinges visible
- Only one shear size
- Max. Opening angle 95°
- Used with Top Rod OS.SE
- Contact pressure adjustment in the shear area is performed via E1.SE
- Adjustment to raise the sash 2.5 mm and lower it 1.5 mm

7

Shear SK.IF-N.E...

- Tilt before turn
- Used in combination with top rod OS.SE.E

Note

- Please observe the specifications concerning screw fixing of hinge parts that are given in the mounting instructions!
- The overview of individual Winkhaus items for profile systems is shown at the beginning of chapter 2 "Lists of fittings".

Item designation	Item no.		Max. sash weight (kg)	VPA1 Pcs/type	VPA2 Pcs/type	VPA3 Pcs/type
SK.IF-N.128.RS	5100569	6	130	10 BD	60 GK	240 EK
SK.IF-N.128.LS	5100574	6	130	10 BD	60 GK	240 EK
SK.IF-N.152.RS	5100606	6	130	10 BD	60 GK	240 EK
SK.IF-N.152.LS	5100607	6	130	10 BD	60 GK	240 EK
SK.IF-N.161.RS	5100565	6	130	10 BD	60 GK	240 EK
SK.IF-N.161.LS	5100568	6	130	10 BD	60 GK	240 EK
SK.IF-N.162.RS	5100545	6	130	10 BD	60 GK	240 EK
SK.IF-N.162.LS	5100552	6	130	10 BD	60 GK	240 EK
SK.IF-N.166.RS	5100541	6	130	10 BD	60 GK	240 EK
SK.IF-N.166.LS	5100542	6	130	10 BD	60 GK	240 EK
SK.IF-N.169.RS	5100537	6	130	10 BD	60 GK	240 EK
SK.IF-N.169.LS	5100538	6	130	10 BD	60 GK	240 EK
SK.IF-N.205.RS	5100557	6	130	10 BD	60 GK	240 EK
SK.IF-N.205.LS	5100560	6	130	10 BD	60 GK	240 EK
SK.IF-N.262.RS	5100603	6	130	10 BD	60 GK	240 EK
SK.IF-N.262.LS	5100605	6	130	10 BD	60 GK	240 EK
SK.IF-N.E.152.RS	5100789	6	130	10 BD	60 GK	240 EK
SK.IF-N.E.152.LS	5100790	6	130	10 BD	60 GK	240 EK
SK.IF-N.E.162.RS	5100784	6	130	10 BD	60 GK	240 EK
SK.IF-N.E.162.LS	5100786	6	130	10 BD	60 GK	240 EK
SK.IF-N.E.205.RS	5100787	6	130	10 BD	60 GK	240 EK
SK.IF-N.E.205.LS	5100788	6	130	10 BD	60 GK	240 EK

RS = right, LS = left

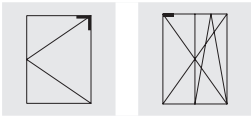
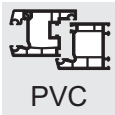

Turn hinge DL.K.IF-N

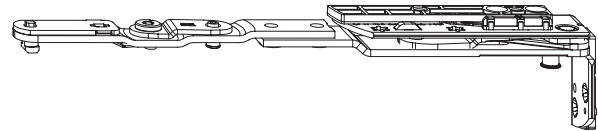

- Installation on the frame
- Used to hold the turn hinge rail DLS.IF
- Fully concealed when the sash is closed
- Max. Opening angle 95°
- Adjustment to raise the sash 2.5 mm and lower it 1.5 mm
- Easy assembly thanks to profile adjustment

Note

- Please observe the specifications concerning screw fixing of hinge parts that are given in the mounting instructions!
- The overview of profile allocation for the individual items is illustrated at the beginning of the chapter "Fittings lists".

Item designation	Item no.		Max. sash weight (kg)	VPA1 Pcs/type	VPA2 Pcs/type	VPA3 Pcs/type
DL.K.IF-N.128.RS	5100815	6	130	10 BD	60 GK	240 EK
DL.K.IF-N.128.LS	5100816	6	130	10 BD	60 GK	240 EK
DL.K.IF-N.152.RS	5100819	6	130	10 BD	60 GK	240 EK
DL.K.IF-N.152.LS	5100820	6	130	10 BD	60 GK	240 EK
DL.K.IF-N.161.RS	5100813	6	130	10 BD	60 GK	240 EK
DL.K.IF-N.161.LS	5100814	6	130	10 BD	60 GK	240 EK
DL.K.IF-N.162.RS	5100809	6	130	10 BD	60 GK	240 EK
DL.K.IF-N.162.LS	5100810	6	130	10 BD	60 GK	240 EK
DL.K.IF-N.166.RS	5100805	6	130	10 BD	60 GK	240 EK
DL.K.IF-N.166.LS	5100806	6	130	10 BD	60 GK	240 EK
DL.K.IF-N.169.RS	5100803	6	130	10 BD	60 GK	240 EK
DL.K.IF-N.169.LS	5100804	6	130	10 BD	60 GK	240 EK
DL.K.IF-N.205.RS	5100811	6	130	10 BD	60 GK	240 EK
DL.K.IF-N.205.LS	5100812	6	130	10 BD	60 GK	240 EK
DL.K.IF-N.262.RS	5100817	6	130	10 BD	60 GK	240 EK
DL.K.IF-N.262.LS	5100818	6	130	10 BD	60 GK	240 EK

RS = right, LS = left

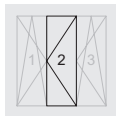
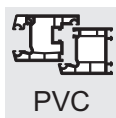

Turn hinge DL.K.IF-N.3

- Hinge component for the centre sash in 3-sash windows
- In combination with turn hinge rail DLS.IF
- Installation on the frame
- Fully concealed when the sash is closed
- Max. Opening angle 95°
- Adjustment to raise the sash 2.5 mm and lower it 1.5 mm
- Easy assembly thanks to profile adjustment

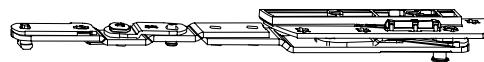

8

Note

- Please observe the information given in the mounting instructions on how to screw the hinge parts for the centre sash on 3-sash windows.
- The overview of individual Winkhaus items for profile systems is shown at the beginning of chapter 2 "Lists of fittings".

Item designation	Item no.		Max. sash weight (kg)	VPA1 Pcs/type	VPA2 Pcs/type	VPA3 Pcs/type
DL.K.IF-N.3.161.RS	5101781	5	80	10 BD	60 GK	240 EK
DL.K.IF-N.3.161.LS	5101782	5	80	10 BD	60 GK	240 EK

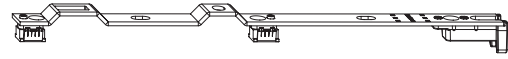
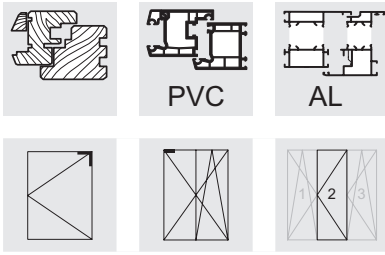

Turn hinge rail DLS.IF

- Used with turn hinge DL...IF-N
- Can be used left and right hand
- Clampable in fitting groove
- Groove centre position 9 mm and 13 mm

Item designation	Item no.		VPA1 Pcs/type	VPA2 Pcs/type	VPA3 Pcs/type
DLS.IF.24-13	5018332	3	10 BD	100 KK	800 EK

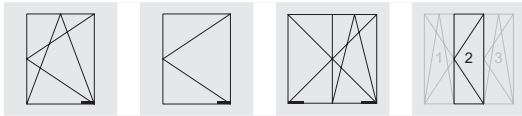
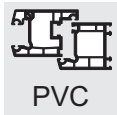

Turn limiter DB.IF

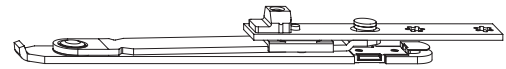

- To prevent window opening too far sideways
- In combination with frame connection RA.DB...IF
- See Installation Instructions for range of applications of turn limiter
- Can be used left and right hand
- Designed for horizontal airgaps 12 mm (+ 1 mm)

Note

- Use of the turn limiter depending on installation situation
- The turn limiter is mandatory if:
 - Reveal depth of surrounding masonry < 120 mm (DIN EN 13126-8, point 4)

10

Item designation	Item no.		Groove centre position	VPA1 Pcs/type	VPA2 Pcs/type	VPA3 Pcs/type
DB.IF	5015697	3	9/13	10 BD	100 KK	800 EK

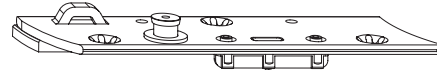
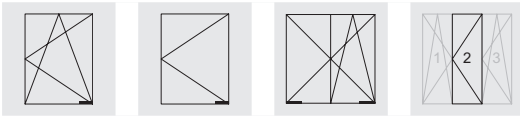
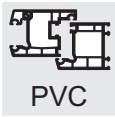

Frame connection RA.DB.K.IF...

- In combination with turn limiter DB.IF
- See Installation Instructions for range of applications of turn limiter
- Easy assembly thanks to profile adjustment

Note

- Please observe the specifications concerning screw fixing of hinge parts that are given in the mounting instructions!
- The overview of profile allocation for the individual items is illustrated at the beginning of the chapter "Fittings lists".

Item designation	Item no.		VPA1 Pcs/type	VPA2 Pcs/type	VPA3 Pcs/type
RA.DB.K.IF.126.RS	5077827	3	50 BL	200 KK	1600 EK
RA.DB.K.IF.126.LS	5077828	3	50 BL	200 KK	1600 EK
RA.DB.K.IF.128.RS	5077823	3	50 BL	200 KK	1600 EK
RA.DB.K.IF.128.LS	5077824	3	50 BL	200 KK	1600 EK
RA.DB.K.IF.152.RS	5077815	3	50 BL	200 KK	1600 EK
RA.DB.K.IF.152.LS	5077816	3	50 BL	200 KK	1600 EK
RA.DB.K.IF.161.RS	5077821	3	50 BL	200 KK	1600 EK
RA.DB.K.IF.161.LS	5077822	3	50 BL	200 KK	1600 EK
RA.DB.K.IF.162.RS	5077817	3	50 BL	200 KK	1600 EK
RA.DB.K.IF.162.LS	5077818	3	50 BL	200 KK	1600 EK
RA.DB.K.IF.166.RS	5077813	3	50 BL	200 KK	1600 EK
RA.DB.K.IF.166.LS	5077814	3	50 BL	200 KK	1600 EK
RA.DB.K.IF.169.RS	5077811	3	50 BL	200 KK	1600 EK
RA.DB.K.IF.169.LS	5077812	3	50 BL	200 KK	1600 EK
RA.DB.K.IF.205.RS	5077819	3	50 BL	200 KK	1600 EK
RA.DB.K.IF.205.LS	5077820	3	50 BL	200 KK	1600 EK
RA.DB.K.IF.262.RS	5077825	3	50 BL	200 KK	1600 EK
RA.DB.K.IF.262.LS	5077826	3	50 BL	200 KK	1600 EK

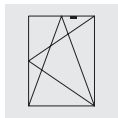
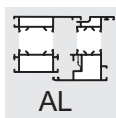
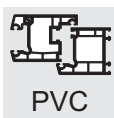
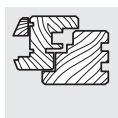

Accessories top rod OS.SE

Anti-Slam Device ZSS OP

- Prevents tilted windows slamming shut in case of light draughts and low window sashes
- For inserting into Top Rod OS.SE
- Can be used left and right hand
- Colour: white

Tilt limiter KBG.OS.SE

- Reduces tilt opening width by approx. 50 mm
- For inserting into Top Rod OS.SE
- Can be used left and right hand
- Recommendation for use: unfavourable sash formats, e. g.
- KBG.OS.SE1 for sash rebate heights < 600 mm
- KBG.OS.SE2 for sash rebate heights < 800 mm



ZSS OP

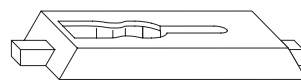

KBG.OS.SE

Item designation	Item no.	VPA1 Pcs/type	VPA2 Pcs/type	VPA3 Pcs/type
ZSS OP WS	2763095	100 BL	1000 KK	8000 EK
KBG.OS.SE.1	4969389	100 BL	1000 KK	8000 EK
KBG.OS.SE.2	4969390	100 BL	1000 KK	8000 EK

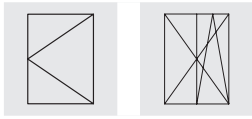
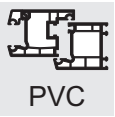

Claw bolt

- Centre lock for turn and double sashes
- Combination of frame component ZV-RT and sash component ZV-FT
- Adjustable for airgaps of 11 to 14 mm
- For left and right hand operation
- Rebate shape see Group 15, installation drawings B-11-...

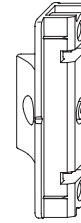

Claw bolt ZV-RT

- Frame part to screw on
- Profile dependent see Group 11, Frame Parts

Claw bolt ZV-FT

- Counter piece for ZV-RT
- Is fixed in the fitting groove hinge side
- Adjustment of contact pressure by means of an Allen key

Item designation	Item no.		Groove centre position	Rebate shape	VPA1 Pcs/type	VPA2 Pcs/type	VPA3 Pcs/type
ZV-FT SL	2359324	2	9/13	10 BL	100 KK	800 EK	

Frame parts

General type descriptions

Designation/short designation/screws



Keep / SBA... / 1



Claw bolt / ZV ... / 2



Security keep / SBS... / 3



Sash lifter / FH ... / 2

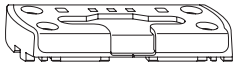

Security keep / SBK... / 4

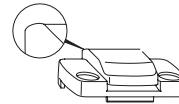

Sash lifter / FH.R. ... / 2
(radius at rear edge)

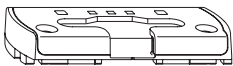

Security tilt keep / SBK... V
Screwed in the prechamber



Sash lifter / FH.L. ... / 2
(long version)

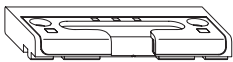

Security tilt keep / SBK... BS / 2
Threshold



Mini vent keep / AS.SBA.K.T / 2



Keep for dual and triple function
element / SBA .. DFE-TFE / 1

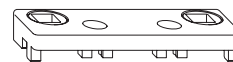

Keep / SA ... / 2

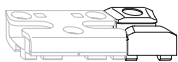

Tilt keep (tilt before turn) /
SBK...E / 1

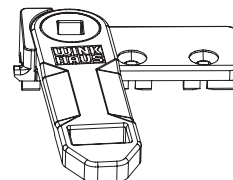

Mini vent keep / AS OF / 2

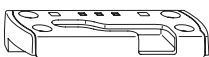

Security keep / SBS.K.PAD (pa-
rallel action/tilt before turn)

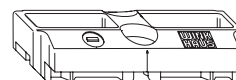

Keep / SA OF / 2

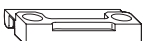







Spacer / FT WSK / 2

Aluplast

Ideal 2000 - 3000

NML 13 mm

UEB 20 mm







SBK 		SBS 		SBA 		AS SBA, ZV-RT, RT RT.MSL 	
SBK.K.61	2892209	SBS.K.61	2892129	SBA.K.61	2892073	AS SBA.K.T.13-3	4937780
SBK.K.61.V	2892170					RT.MSL.3	5007006
						ZV-RT 60 RC SL	2312155
SBK.K.E/PAD 		BK, FT 		FH 		SA, SA OF	
SBK.K.E.3	4935945	BK 60 SL	1919553	FH.152	4949428	SA 152 SL	2366946
		BK 61 RC SL	5026717	FH.R.152	4995853	SA OF 61 SL	4940007
		FT WSK 61	1497653	FH.R.152.M10	5011126		

Aluplast

Ideal 4000 - 8000, Energeto, Energeto Neo

NML 13 mm

UEB 20 mm







SBK 		SBS 		SBA 		AS SBA, ZV-RT, RT RT.MSL 	
SBK.K.161	2861621	SBS.K.161	2861672	SBA.K.161	2824071	AS SBA.K.T.13-5	4937782
SBK.K.161.I.P5	5087903	SBS.K.161.I.P5	5087904	SBA.K.161.DFE-TFE.LS	4935788	RT.MSL.3	5007006
SBK.K.161.LK.SC	4949425	SBS.K.161.M3	4927769	SBA.K.161.DFE-TFE.RS	4935789	SBS.K.PAB.161.P10.LS	5097271
SBK.K.161.M3	4927851	SBS.K.66.P5	4936140	SBA.K.161.P5.DFE-TFE.LLS	5091974	SBS.K.PAB.161.P10.RS	5097270
SBK.K.161.V	4927435			SBA.K.161.P5.DFE-TFE.LRS	5091973	ZV-RT 161 RC SL	1213945
SBK.K.66.P5	4936142			SBA.K.161.S.40	5001559		
SBK.K.66.V.P5	4936143			SBA.K.66	4932001		
SBK.K.SP.161	5010275						
SBK.K.E/PAD 		BK, FT 		FH 		SA, SA OF	
SBK.K.E.5	4935956	BK 61 RC SL	5026717	FH.161	4949431	SA 66 SL	2209887
SBS.K.PAD.161.LS	4995615	FT WSK 66	1530185	FH.R.161	4995855	SA OF 161 SL	5031823
SBS.K.PAD.161.P10.LS	5097273						
SBS.K.PAD.161.P10.RS	5097272						
SBS.K.PAD.161.RS	4995614						

Brüggmann / Salamander

System AD

NML 13 mm

UEB 20 mm







SBK 		SBS 		SBA 		AS SBA, ZV-RT, RT RT.MSL 	
SBK.K.94.P7	4927718	SBS.K.94.P7	4927717	SBA.K.94.P7	4927716	AS SBA.K.T.13-3	4937780
SBK.K.94.V.P7	4927719					RT.MSL.3	5007006
						ZV-RT 452/13 SL	2074732
SBK.K.E/PAD 		BK, FT 		FH 		SA, SA OF	
SBK.K.E.3	4935945	BK 552 RC SL	2522321	FH.152	4949428	SA 152 SL	2366946
		FT WSK152	1787079	FH.R.152	4995853		
				FH.R.152.M10	5011126		

Brüggmann / Salamander

System MD



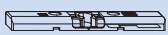



NML 13 mm

UEB 20 mm

SBK 		SBS 		SBA 		AS SBA, ZV-RT, RT RT.MSL 	
SBK.K.94.P7	4927718	SBS.K.94.P7	4927717	SBA.K.94.P7	4927716	AS SBA.K.T.13-3	4937780
SBK.K.94.V.P7	4927719					RT.MSL.3	5007006
						ZV-RT 452/13 SL	2074732
SBK.K.E/PAD 		BK, FT 		FH 		SA, SA OF	
SBK.K.E.3	4935945	BK 552 RC SL	2522321	FH.152	4949428	SA 152 SL	2366946
		FT WSK152	1787079	FH.R.152	4995853		
				FH.R.152.M10	5011126		



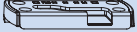



**Deceuninck
iCOR, Elegant**

**NML 13 mm
UEB 21 mm**

SBK 		SBS 		SBA 		AS SBA, ZV-RT, RT RT.MSL 	
SBK.K.169	4926366	SBS.K.169	4926363	SBA.K.169	5073712	AS SBA.K.T.13-4	4937781
SBK.K.169.P7	4974642	SBS.K.169.P7	4974641	SBA.K.169_0,7	5073713	RT.MSL.9-13	5032095
SBK.K.169/21.P7	5042728					ZV-RT 169 RC SL	5033656
SBK.K.SP.169.P7	5065629						
SBK.K.E/PAD 		BK, FT 		FH 		SA, SA OF	
SBK.K.E.4	4935954	BKS 169 RC-V SL	2356852	FH.205	4949429	SA 169 SL	2359447
SBS.K.PAD.169.LS	4995621	FT WSK169	2356596	FH.L.205	5002710	SA OF 169 SL	5019156
SBS.K.PAD.169.RS	4995620			FH.R.205	4995854		







**Deceuninck
Zendow, Neo**

**NML 13 mm
UEB 20 mm**

SBK 		SBS 		SBA 		AS SBA, ZV-RT, RT RT.MSL 	
SBK.K.169	4926366	SBS.K.169	4926363	SBA.K.169	5073712	AS SBA.K.T.13-4	4937781
SBK.K.169.P7	4974642	SBS.K.169.P7	4974641	SBA.K.169_0,7	5073713	RT.MSL.3	5007006
SBK.K.169/21.P7	5042728					ZV-RT 169 RC SL	5033656
SBK.K.SP.169.P7	5065629						
SBK.K.E/PAD 		BK, FT 		FH 		SA, SA OF	
SBK.K.E.4	4935954	BKS 169 RC-V SL	2356852	FH.205	4949429	SA 169 SL	2359447
SBS.K.PAD.169.LS	4995621	FT WSK169	2356596	FH.L.205	5002710	SA OF 169 SL	5019156
SBS.K.PAD.169.RS	4995620			FH.R.205	4995854		







**Gealan
3000**

**NML 13 mm
UEB 20 mm**

SBK 		SBS 		SBA 		AS SBA, ZV-RT, RT RT.MSL 	
SBK.K.162	4929797	SBS.K.162	4929798	SBA.K.162	4929796	AS SBA.K.T.13-4	4937781
SBK.K.162.P7	4964887	SBS.K.162.M3	5040828	SBA.K.62	4926222	RT.MSL.3	5007006
SBK.K.162.S.P7	5056334	SBS.K.162.P7	4964886			ZV-RT 162 SL	2088350
SBK.K.162.V.P7	4964888	SBS.K.162.S.P7	5056333			ZV-RT 62 SL	2094258
SBK.K.62	4929831	SBS.K.169.P7	4974641				
SBK.K.E/PAD 		BK, FT 		FH 		SA, SA OF	
SBK.K.E.4	4935954	BK 134 SL	2103935	FH.205	4949429	SA 62 SL6 SL	2749461
		BK 61 RC SL	5026717	FH.L.205	5002710		
		FT WSK 62	1348121	FH.R.205	4995854		







**Gealan
6000, 7000, 8000, 9000**

**NML 13 mm
UEB 20 mm**

SBK 		SBS 		SBA 		AS SBA, ZV-RT, RT RT.MSL 	
SBK.K.162	4929797	SBS.K.162	4929798	SBA.K.162	4929796	AS SBA.K.T.13-4	4937781
SBK.K.162.P7	4964887	SBS.K.162.M3	5040828			RT.MSL.3	5007006
SBK.K.162.S.P7	5056334	SBS.K.162.P7	4964886			ZV-RT 162 SL	2088350
SBK.K.162.V	4929799	SBS.K.162.S	4988102			ZV-RT 62 SL	2094258
SBK.K.162.V.P7	4964888	SBS.K.162.S.P7	5056333				
SBK.K.SP.162	5030281						
SBK.K.E/PAD 		BK, FT 		FH 		SA, SA OF	
SBK.K.E.4	4935954	BK 134 SL	2103935	FH.205	4949429	SA 62 SL6 SL	2749461
SBS.K.PAD.162.LS	4995617	FT WSK 62	1348121	FH.L.205	5002710		
SBS.K.PAD.162.RS	4995616			FH.R.205	4995854		







Gealan Kubus

NML 13 mm
UEB 20 mm

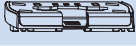
SBK 		SBS 		SBA 		AS SBA, ZV-RT, RT RT.MSL 	
SBK.K.262.P7	5050623	SBS.K.262.P7	5050622	SBA.K.562.P7 KT	5004126	ZV-RT 162 SL	2088350
SBK.K.E/PAD 		BK, FT 		FH 		SA, SA OF	
		BK 134 SL	2103935				
		FT WSK162	1719578				







KBE (Profine) 70 AD / 70 MD / 88+

NML 13 mm
UEB 20 mm

SBK 		SBS 		SBA 		AS SBA, ZV-RT, RT RT.MSL 	
SBK.K.205.P5	4996028	SBS.K.205	5039488	SBA.K.205.P5	2922210	AS SBA.K.T.13-4	4937781
SBK.K.205.S.P5	5046012	SBS.K.205.P5	4996029			RT.MSL.3	5007006
SBK.K.205.V.P5	4996027	SBS.K.205.S.P5	5046011			ZV-RT 169 RC SL	5033656
SBK.K.SP.162.M3	5073640						
SBK.K.E/PAD 		BK, FT 		FH 		SA, SA OF	
SBK.K.E.4	4935954	BKS 169 RC-V SL	2356852	FH.205	4949429	SA 169 SL	2359447
SBS.K.PAD.205.LS	4995625	FT WSK205	1809590	FH.L.205	5002710	SA OF 169 SL	5019156
SBS.K.PAD.205.RS	4995624			FH.R.205	4995854		



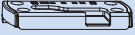



KBE (Profine) 76 AD, 76 MD

NML 13 mm
UEB 20 mm

SBK 		SBS 		SBA 		AS SBA, ZV-RT, RT RT.MSL 	
SBK.K.205.P5	4996028	SBS.K.205	5039488	SBA.K.205.P5	2922210	AS SBA.K.T.13-4	4937781
SBK.K.205.S.P5	5046012	SBS.K.205.P5	4996029			RT.MSL.3	5007006
SBK.K.205.V.P5	4996027	SBS.K.205.S.P5	5046011			ZV-RT 169 RC SL	5033656
SBK.K.SP.162.M3	5073640						
SBK.K.E/PAD 		BK, FT 		FH 		SA, SA OF	
SBK.K.E.4	4935954	BKS 169 RC-V SL	2356852	FH.205	4949429	SA 169 SL	2359447
SBS.K.PAD.205.LS	4995625	FT WSK205	1809590	FH.L.205	5002710	SA OF 169 SL	5019156
SBS.K.PAD.205.RS	4995624			FH.R.205	4995854		

Kömmerling (Profine) 76 AD, 76 MD

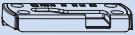
NML 13 mm
UEB 20 mm







SBK 		SBS 		SBA 		AS SBA, ZV-RT, RT RT.MSL 	
SBK.K.205.P5	4996028	SBS.K.205	5039488	SBA.K.205.P5	2922210	AS SBA.K.T.13-4	4937781
SBK.K.205.S.P5	5046012	SBS.K.205.P5	4996029			RT.MSL.3	5007006
SBK.K.205.V.P5	4996027	SBS.K.205.S.P5	5046011			ZV-RT 169 RC SL	5033656
SBK.K.SP.162.M3	5073640						
SBK.K.E/PAD 		BK, FT 		FH 		SA, SA OF	
SBK.K.E.4	4935954	BKS 169 RC-V SL	2356852	FH.205	4949429	SA 169 SL	2359447
SBS.K.PAD.205.LS	4995625	FT WSK205	1809590	FH.L.205	5002710	SA OF 169 SL	5019156
SBS.K.PAD.205.RS	4995624			FH.R.205	4995854		

LB.Profile

PAD / PMD / PCD

NML 13 mm

UEB 20 mm







SBK 		SBS 		SBA 		AS SBA, ZV-RT, RT RT.MSL 	
SBK.K.12	4926374	SBS.K.12	4926373	SBA.K.12	4926372	AS SBA.K.T.13-3	4937780
SBK.K.12.V	4926375					RT.MSL.3	5007006
						ZV-RT 60 RC SL	2312155
SBK.K.E/PAD 		BK, FT 		FH 		SA, SA OF	
SBK.K.E.3	4935945	BK 60 SL	1919553	FH.152	4949428	SA SL	1895985
		FT WSK 76	1500787	FH.R.152	4995853		
				FH.R.152.M10	5011126		

Rehau

Euro-Design 86

NML 13 mm

UEB 20 mm







SBK 		SBS 		SBA 		AS SBA, ZV-RT, RT RT.MSL 	
SBK.K.60	2861584	SBS.K.60	2861656	SBA.K.160	4933116	AS SBA.K.T.13-3	4937780
SBK.K.60.M3	4927850	SBS.K.60.M3	4927768	SBA.K.60	2824046	RT.MSL.3	5007006
SBK.K.60.V	4927433			SBA.K.60 -0,3	4931375	ZV-RT 60 SL	1975336
SBK.K.SP.60/260	5030280						
SBK.K.E/PAD 		BK, FT 		FH 		SA, SA OF	
SBK.K.E.60	4942833	BK 60 SL	1919553	FH.60	4949432	SA 60 SL	1929209
		BK 61 RC SL	5026717			SA OF 60 SL	2859521
		FT WSK 60	1345393				
		FT WSK 61	1497653				

Rehau

Geneo, Synego

NML 13 mm

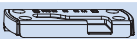
UEB 20 mm







SBK 		SBS 		SBA 		AS SBA, ZV-RT, RT RT.MSL 	
SBK.K.160	4933118	SBS.K.160.S16.WK2	4941217	SBA.K.160	4933116	AS SBA.K.T.13-4	4937781
SBK.K.SP.60/260	5030280	SBS.K.160.WK2	4933803			RT.MSL.3	5007006
		SBS.K.60.M3	4927768			ZV-RT 160	4933117
SBK.K.E/PAD 		BK, FT 		FH 		SA, SA OF	
SBK.K.E.4	4935954	BK 60 SL	1919553	FH.205	4949429	SA 60 SL	1929209
SBS.K.PAD.160.LS	4995613	FT WSK 60	1345393	FH.L.205	5002710		
SBS.K.PAD.160.RS	4995612			FH.R.205	4995854		

Salamander

bluEvolution 82



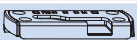



NML 13 mm

UEB 20 mm

SBK 		SBS 		SBA 		AS SBA, ZV-RT, RT RT.MSL 	
SBK.K.94.P7	4927718	SBS.K.94.P7	4927717	SBA.K.152.DFE-TFE. LS	5050760	AS SBA.K.T.13-3	4937780
SBK.K.94.V.P7	4927719	SBS.K.94.P7.W	4978502	SBA.K.152.DFE-TFE. RS	5050729	RT.MSL.3	5007006
				SBA.K.152.P5.DFE- TFE.LS	4990374	ZV-RT 134 SL	2864478
				SBA.K.152.P5.DFE- TFE.RS	4990373		
				SBA.K.94.P7	4927716		
SBK.K.E/PAD 		BK, FT 		FH 		SA, SA OF	
		BK 134 SL	2103935	FH.152	4949428	SA 134 SL	2367181
		FT WSK134	1537651	FH.R.152	4995853		
				FH.R.152.M10	5011126		



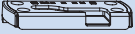



**Salamander
bluEvolution 92**

NML 13 mm
UEB 20 mm

SBK 		SBS 		SBA 		AS SBA, ZV-RT, RT RT.MSL 	
SBK.K.128	4941002	SBS.K.128	4941001	SBA.K.28	4926452	AS SBA.K.T.13-4	4937781
SBK.K.128.V	4941004			SBA.K.28.DFE-TFE.LS	4935783	RT.MSL.3	5007006
				SBA.K.28.DFE-TFE.RS	4935784	ZV-RT 134 SL	2864478
				SBA.K.28.P5	5059941		
SBK.K.E/PAD 		BK, FT 		FH 		SA, SA OF	
SBS.K.PAD.128.LS	4995607	BK 134 SL	2103935	FH.205	4949429	SA 134 SL	2367181
SBS.K.PAD.128.RS	4995606	FT WSK134	1537651	FH.L.205	5002710		
				FH.R.205	4995854		

**Salamander
greenEvolution**







NML 13 mm
UEB 20 mm

SBK 		SBS 		SBA 		AS SBA, ZV-RT, RT RT.MSL 	
SBK.K.94.P7	4927718	SBS.K.94.P7	4927717	SBA.K.152.DFE-TFE.LS	5050760	AS SBA.K.T.13-3	4937780
SBK.K.94.V.P7	4927719	SBS.K.94.P7.W	4978502	SBA.K.152.DFE-TFE.RS	5050729	RT.MSL.3	5007006
				SBA.K.152.P5.DFE-TFE.LS	4990374	ZV-RT 134 SL	2864478
				SBA.K.152.P5.DFE-TFE.RS	4990373		
				SBA.K.94.P7	4927716		
SBK.K.E/PAD 		BK, FT 		FH 		SA, SA OF	
		BK 134 SL	2103935	FH.152	4949428	SA 134 SL	2367181
		FT WSK134	1537651	FH.R.152	4995853		
				FH.R.152.M10	5011126		

11







**Schüco
Corona 70 / Corona SI 82**

NML 13 mm
UEB 20 mm





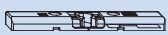

SBK 		SBS 		SBA 		AS SBA, ZV-RT, RT RT.MSL 	
SBK.K.166	4930269	SBS.K.166	4930271	SBA.K.166	4930272	AS SBA.K.T.13-3	4937780
SBK.K.166.V	4930270					RT.MSL.3	5007006
SBK.K.SP.166	5018520					ZV-RT 60 SL	1975336
SBK.K.E/PAD 		BK, FT 		FH 		SA, SA OF	
SBK.K.E.3	4935945	BK 60 SL	1919553	FH.152	4949428	SA 60 SL	1929209
SBS.K.PAD.166.LS	4995619	FT WSK 61	1497653	FH.R.152	4995853		
SBS.K.PAD.166.RS	4995618			FH.R.152.M10	5011126		

**Schüco
Living**





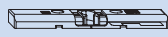

NML 13 mm
UEB 20 mm

SBK 		SBS 		SBA 		AS SBA, ZV-RT, RT RT.MSL 	
SBK.K.166	4930269	SBS.K.166	4930271	SBA.K.166	4930272	AS SBA.K.T.13-3	4937780
SBK.K.166.V	4930270					RT.MSL.3	5007006
						ZV-RT 60 SL	1975336
SBK.K.E/PAD 		BK, FT 		FH 		SA, SA OF	
SBK.K.E.3	4935945	BK 60 SL	1919553	FH.152	4949428	SA 60 SL	1929209
SBS.K.PAD.166.LS	4995619	FT WSK 61	1497653	FH.R.152	4995853		
SBS.K.PAD.166.RS	4995618			FH.R.152.M10	5011126		

Trocal (Profine)
76 AD, 76 MD
NML 13 mm
UEB 20 mm

SBK 		SBS 		SBA 		AS SBA, ZV-RT, RT RT.MSL 	
SBK.K.205.P5	4996028	SBS.K.205	5039488	SBA.K.205.P5	2922210	AS SBA.K.T13-4	4937781
SBK.K.205.S.P5	5046012	SBS.K.205.P5	4996029			RT.MSL.3	5007006
SBK.K.205.V.P5	4996027	SBS.K.205.S.P5	5046011			ZV-RT 169 RC SL	5033656
SBK.K.SP162.M3	5073640						
SBK.K.E/PAD 		BK, FT 		FH 		SA, SA OF	
SBK.K.E.4	4935954	BKS 169 RC-V SL	2356852	FH.205	4949429	SA 169 SL	2359447
SBS.K.PAD.205.LS	4995625	FT WSK205	1809590	FH.L.205	5002710	SA OF 169 SL	5019156
SBS.K.PAD.205.RS	4995624			FH.R.205	4995854		

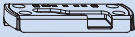
Veka
Softline 70 AD/MD, Softline 82 AD/MD, Softline 76 AD/MD, Artline 82
NML 13 mm
UEB 20 mm

SBK 		SBS 		SBA 		AS SBA, ZV-RT, RT RT.MSL 	
SBK.K.152	4938546	SBS.K.152	4990061	SBA.K.152	5050727	AS SBA.K.T13-3	4937780
SBK.K.152.P5	4939133	SBS.K.152.M3	4984031	SBA.K.152.DFE-TFE.LS	5050760	RT.MSL.3	5007006
SBK.K.152.V	4938547	SBS.K.152.P5	4938954	SBA.K.152.DFE-TFE.RS	5050729	ZV-RT 452/13 SL	2074732
SBK.K.152.V.P5	4939137	SBS.K.152.S	4937038	SBA.K.152.P5.DFE-TFE.LS	4990374		
SBK.K.SP152	5055019			SBA.K.152.P5.DFE-TFE.RS	4990373		
SBK.K.SP152.P5	5055020			SBA.K.152+0,5	5050726		
				SBA.K.552+0,5	5050725		
SBK.K.E/PAD 		BK, FT 		FH 		SA, SA OF	
SBK.K.E.3	4935945	BK 552 RC SL	2522321	FH.152	4949428	SA 152 SL	2366946
SBS.K.PAD.152.LS	4995611	FT WSK152	1787079	FH.R.152	4995853	SA OF 152 SL	2859505
SBS.K.PAD.152.RS	4995610			FH.R.152.M10	5011126		

Notes on these assembly instructions

Prerequisites:

The mounting instructions are designed for mounting Winkhaus activPilot fittings for windows and glazed doors only. Fittings are designed for the following sash rebate sizes and sash weights:

- Min. Sash rebate width 380 mm
- Max. Sash rebate width 1725 mm
- From 1475 mm sash rebate width with additional shear ZSR
- Min. Sash rebate height 230 mm
- Max. Sash rebate height 2800 mm
- Max. Sash size 3 m²
- Max. Sash weight 130 kg
- Ratio between sash rebate width: sash rebate height ≤ 2:1
- Airgap at bottom side 12 +1 mm

i Note: In order to ascertain the permissible sash sizes and sash weights, please refer to the diagrams in the chapter “General Product Information”.

Observe instructions on window profile

You must specifically take into account information provided by the profile manufacturer or system owner when determining the maximum sash sizes and sash weights!

Persons involved in mounting fittings must have read and understood this fitting guide. Observe production liability information for all work with fittings. Manufacturer will accept no liability in cases of failure to comply with this guide, deployment of insufficiently qualified staff and unauthorised alterations.

The respective overall fitting must be selected from the original fitting components range. Winkhaus accepts no liability if non-original or unauthorised system accessory parts are used.

Standard profile dimensions

See figures: Profile section offset on the inside, profile section flush on the inside. The fitting system is suitable for all PVC-U windows with standard fitting groove (eurogroove position 13 mm) and designed for an airgap of 12 mm and in case of offset profiles on the inside for overlaps of 20 mm. In addition, activPilot Topstar can also be used for flush-fitting windows on the inside. For minimum gap widths, see graphic “Table of gap dimensions for windows that are flush or offset on the inside.”

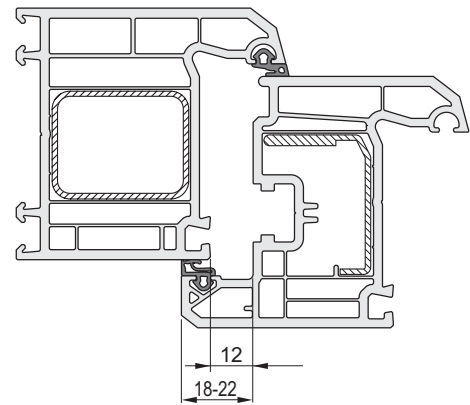

Offset profile section on the inside

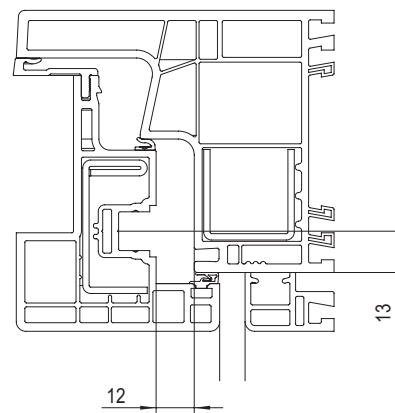

Flush profile section

Please observe screwing advice!



Important: The screw connections of the load-bearing fitting components, such as corner, shear and sash hinges must be performed according to the TBDK guidelines. Adapt the drilling diameter for the fixing screws, the screw diameter and the screw length to the load situation.



Important: In case of windows with rebate seal system, the frame and hinge parts in water-bearing profile levels must be screwed in a way to avoid water entering into profile levels that cannot be drained afterwards. Please observe the information given by your system supplier.



Please note! Winkhaus does not provide fastening screws for fitting. Always use fastening screws suitable for the window type and window dimensions.

Shortening the fittings

A detailed description on shortening of fittings is available here. This description will be referred to in these assembly instructions.

See figure: Fittings prior to punching

- Always insert the face plate (1) and drive rod (2) perpendicularly from the top with the face plate (1) pointing to the pressure cylinder.

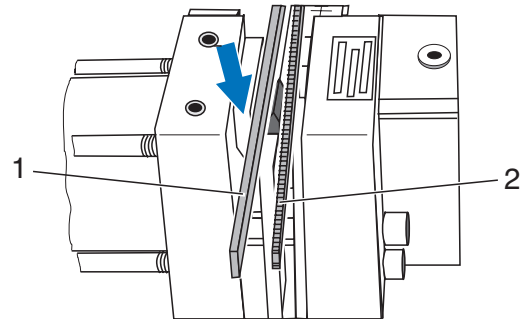

Fittings prior to punching

See figure: Fittings after punching

- After punching, always remove the face plate (1) and drive rod (2) perpendicularly in an upwards direction.

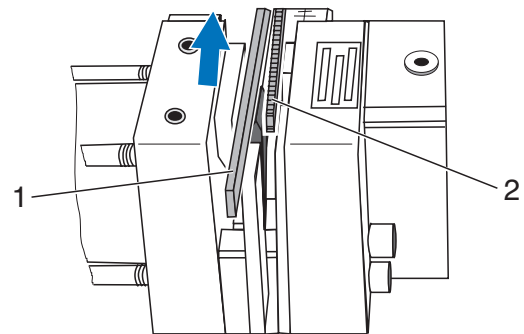

Fittings after punching

See figure: Cleaning the supporting surfaces

- Keep the supporting surfaces (3 and 4) clean.

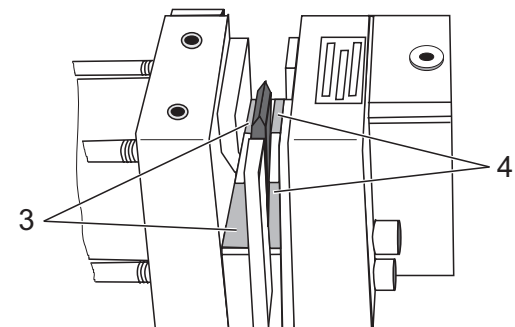

Cleaning the supporting surfaces

Shorten the drive rod GAM (central handle position)

See figure: Marking GAM

- Set measuring value FFH on the measuring device to the GAM mark.



Please note! If the GAM scale is displaced by one submarking, this corresponds to a longitudinal shift of 2 mm.

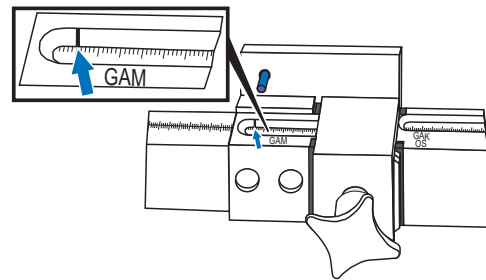

Marking GAM

See figure: Position for shortening drive rod

- Position the GAM drive rod at the scale; slot drill hole (2) onto bolt (1).
- Turn the GAM drive rod around, and slot the drill hole (3) onto the bolt (1), then trim the other side.
- Shorten the drive rod using the fitting punch.

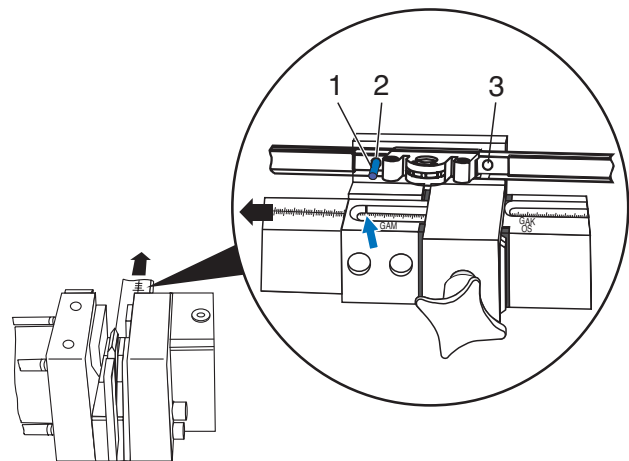

Position for shortening drive rod

Cutting of double sash drive rods GASM

GASM.800

See figure: Cutting instructions GASM

- Adjust the ruler to FFH + 400 mm
(example: measured FFH = 567;
adjust ruler to 567 mm + 400 mm = 967 mm).
- Connect the drive to the marked hole on the ruler
(arrows pointing to cutter).
- Cut off the element.

GASM.1050 - GASM.2300

See figure: Cutting instructions GASM

- Adjust the ruler to FFH (sash rebate height).
- Connect the drive to the marked hole on the ruler
(arrows pointing to cutter).
- In case of GASM.1050 please make sure that the bolt in the elongated hole is positioned as indicated (red arrow).
- Cut off the element.
- GASM.1050 is always used in combination with corner drive E3.

i Note: The double-sash drive rod must be trimmed before delivery.

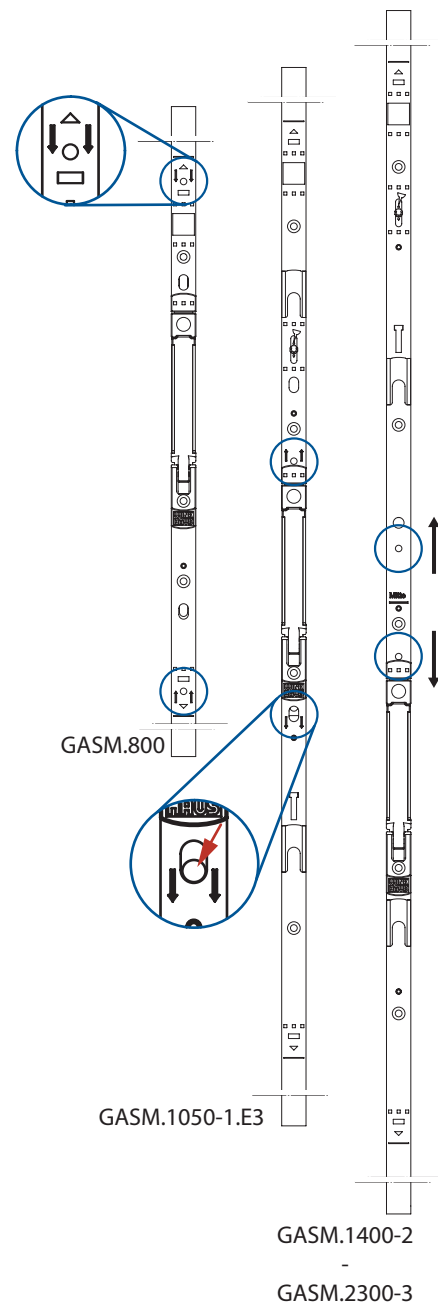

Cutting instructions GASM

Shorten the GAK / GASK drive rod (constant handle position) and top rod OS



Note: The double-sash drive rod must be trimmed before delivery.

See figure: Markings GAK and OS

- Set the measuring value FFH (GAK/GASK) or FFB (OS) on the measuring device to the GAK/OS mark.

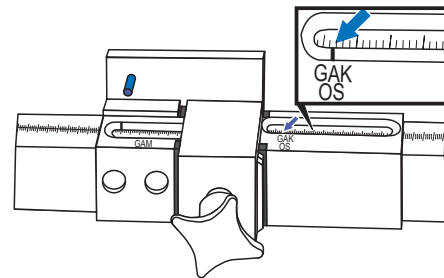

Markings GAK and OS

See figure: Position for shortening drive rod and/or top rod

- Cutting the top rod OS...
 - Position the drive rod GAK/GASK (fixed handle position) (1) or the top rod OS (1) at the bolt (2).
 - Shorten the drive rod (1) or the top rod (1).

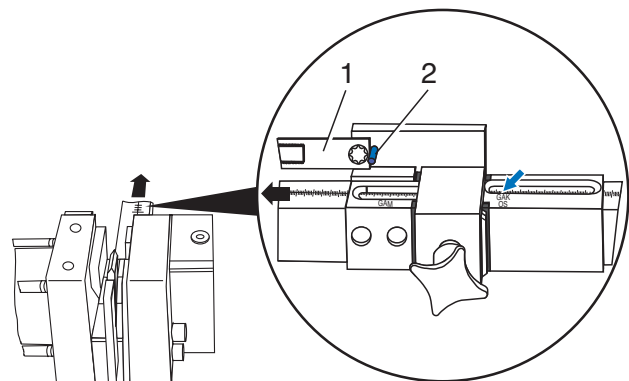

Position for shortening drive rod and/or top rod

Only applies to top rod OS1.600 (OS1.PA.600/OS.XL):

See figure: Position for shortening top rod

- Position the top rod (1) with square holes at bolt (2). At the same time press the offset (see arrow) against the bolt (2).
- Shorten the top rod (1).

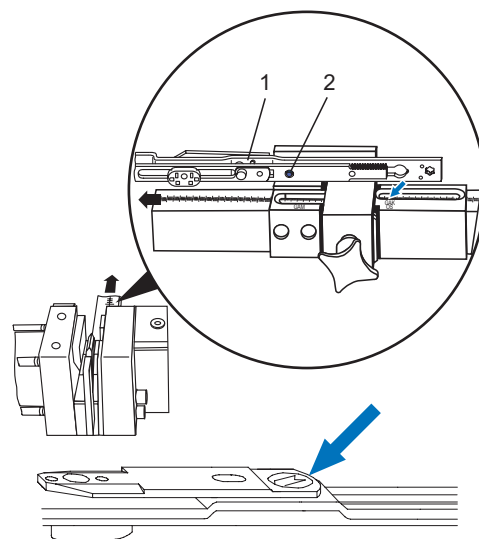

Position for shortening top rod

Mounting of fittings on sash

Utilisation of the clampable “E...N” corner drive with black clamping piece

In case the “E...N” corner hinge (with black clamping piece) is used, please keep in mind that the second (external) screw may only be applied if another component is connected (see illustration below).



If a second screw is fixed to the clamping piece and tightened without joining an additional component, the fitting system might be difficult to operate.

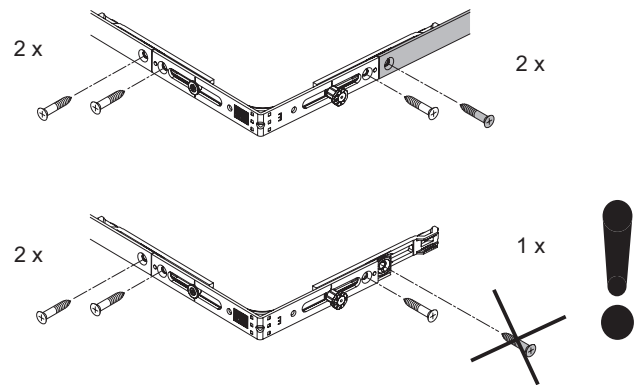

Turn-tilt type - Rectangular window

Prepare the window for fitting. Then proceed as follows:



Note: The following figures refer to a window for right hand use. When fitting a window for left-hand use, the figures will be mirror-inverted.

The following also applies:

- When viewing the window from the inside, the symbol is depicted as a full line.
- When viewing the window from the outside, the symbol is depicted as a dotted line.

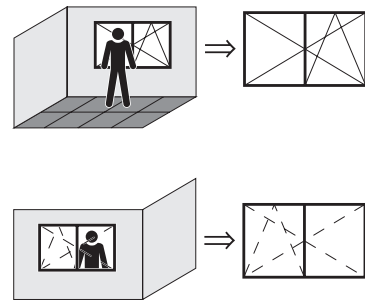

Determine the handle height:

Handle height for drive rod GAM

See figure: Sash rebate height FFH with central handle height GM

If you use a GAM drive rod ... (central handle position), the dimension GM is half the sash rebate height FFH.

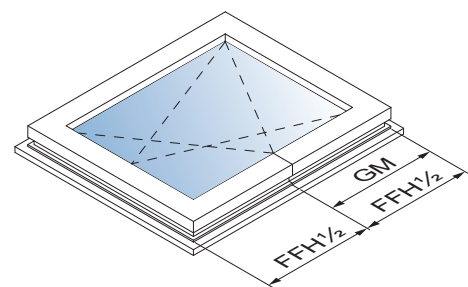

Sash rebate height FFH with central handle height GM

Handle height for drive rod GAK

See figure: Sash rebate height FFH with constant handle position GK

If you use a GAK drive rod ... (constant handle position), dimension GK changes to reflect the sash rebate height FFH. The exact dimensions are specified in the following table.

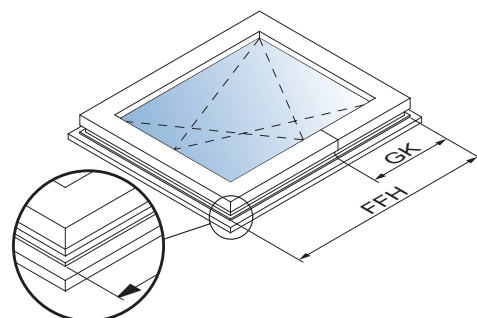

Sash rebate height FFH with constant handle position GK

See figure: Synoptical table: sash rebate height (FFH) / handle position (GK)

The table on the right gives a survey on the handle height (GK) of GAK with regard to the sash rebate height (FFH).

FFH	GK
230 – 324	GK = 114 *
325 – 420	GK = 114 *
421 – 460	GK = 210
461 – 700	GK = 210
701 – 850	GK = 260
851 – 1100	GK = 375
1101 – 1325	GK = 550
1326 – 1525	GK = 550
1526 – 1775	GK = 550
1776 – 2000	GK = 1050
2001 – 2225	GK = 1050

Synoptical table: sash rebate height (FFH) / handle position (GK)
 * Requires the use of E3 corner drive

See figure: Scale drawing “Gear lock”

- Drill holes for gear case (ø 12 mm) as per scale drawing.

Mill the gear housing from the rebate side.

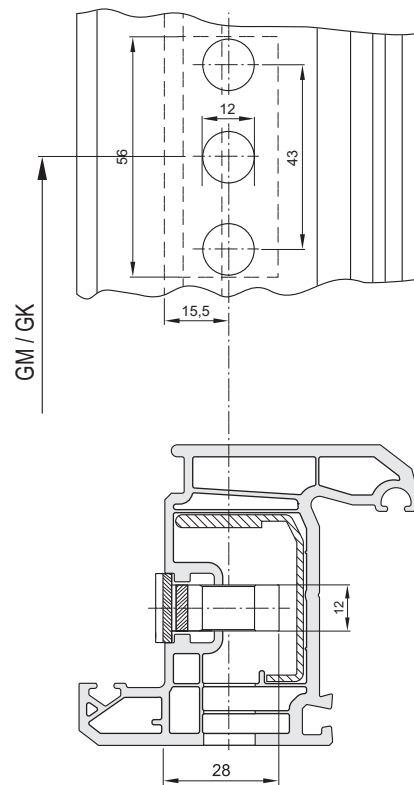

Scale drawing “Gear lock”

Table of gap dimensions for windows that are flush or offset on the inside

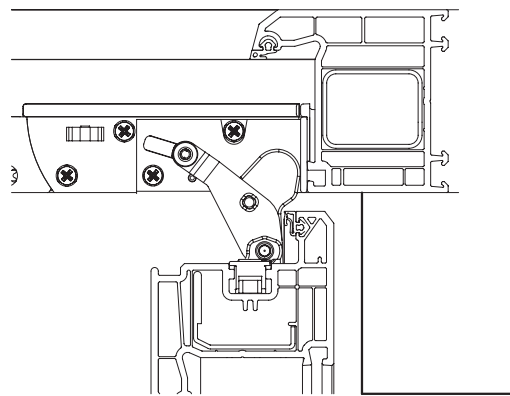
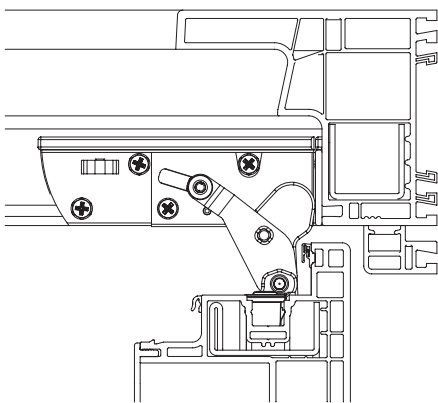
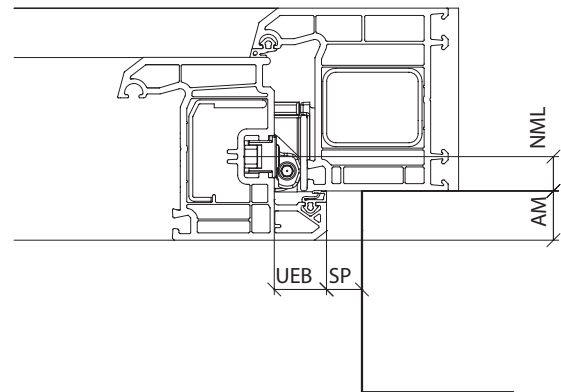
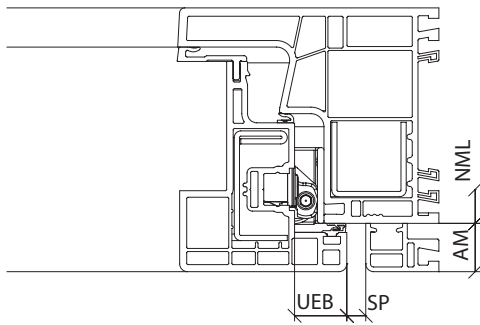

13

AM	UEB	SP 13 mm NML
18	20	7
20	20	9
22	20	11
24	20	13

AM = overlap dimension
 UEB = overlap
 NML = groove centre position
 SP = Min. gap dimension
 The gap dimensions also depend on the shape and radiuses of the overlap.

See figure: Corner drive E1

- Mounting of interlocking rods:
 - Fit the corner drive (2) into the fitting groove at the top of the sash so that the octagonal bolt is on the top side.
 - Fit the corner drive (1) into the fitting groove at the bottom of the sash so that the octagonal bolt is on the underside
 - Fix both corner drives (1, 2) on the drive side with a single screw each.
 - Measure the sash rebate height (FFH).

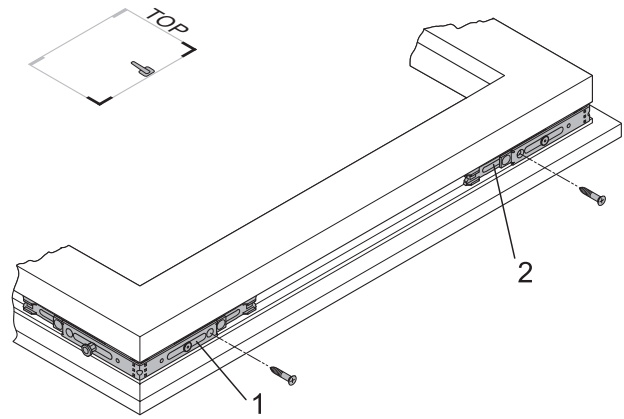

Corner drive E1

See figure: Drive rod GAM/GAK

- Cut the drive rod according to the instructions.
- Mount the drive rod:
 - Abut the drive rod (2) flush against the corner drive (3).
 - Allow the teeth on the drive rod to click into position on the gear rack on the corner drive.
 - Clip the drive rod into the corner drive (1) in the same way.
 - Press the drive rod into the eurogroove.
 - Screw the drive rod from the bottom up.

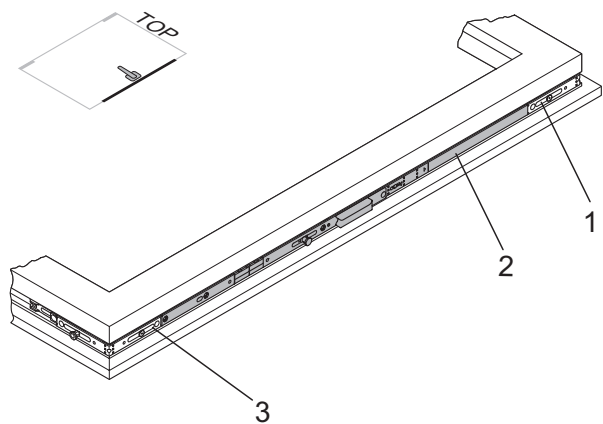

Drive rod GAM/GAK



Note: Please make sure that the installation position of the drive rod is correct!

See figure: Corner Drive E1.SE

- Fit the corner drive (1) into the fitting groove at the top of the sash so that the octagonal bolt is on the hinge side.
 - Fasten the corner drive on the sash using a screw (2).
 - Measure the sash rebate width (FFB).
- Cut the top rod (see chapter 'Shortening the fittings').

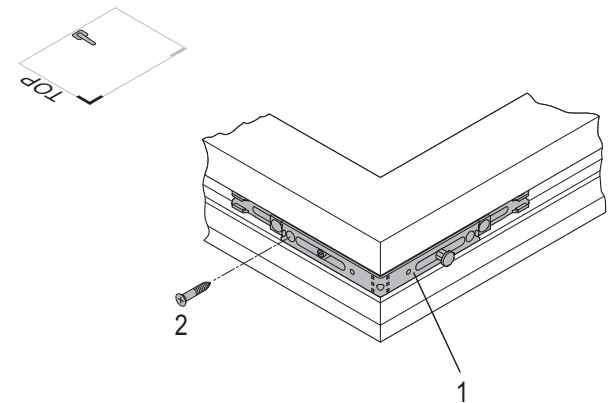

Corner Drive E1.SE



Note: For FFH < approx. 600 mm (depending on profile), place tilt limiter on top rod OS... (2).

See figure: Top Rod OS.SE

- Insert the top rod and screw into position.
 - Fit the top rod flush against the corner drive (1).
 - Allow the gear teeth to click into place on the rack in the corner drive.
 - Clip the top rod into the corner drive (3) in the same way.
 - Press the top rod into the fitting groove.
 - Screw the top rod from the hinge side to the drive side.



Note: For FFH < approx. 600 mm (depending on profile), place tilt limiter on top rod OS... (2).

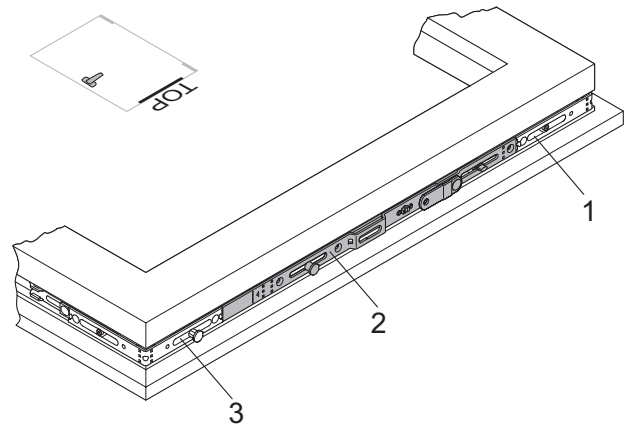

Top Rod OS.SE

See figure: Interlocking rod M/MK (hinge side)

- Install Interlocking Rod on the hinge side.
 - Fit the interlocking rod (1) flush against the corner drive (2)
 - Click the interlocking rod gears into the teeth of the corner drive.
 - Press the interlocking rod into the fitting groove.
 - Screw the interlocking rod from the top down.
 - Tighten the screw (3) fully to release the central fastening.



Note: For a sash rebate height (FFH) and/or sash rebate width (FFB) of approx 800 mm (depending on the profile) an interlocking rod should also be fitted hinge-side and/or horizontally at the bottom / top.

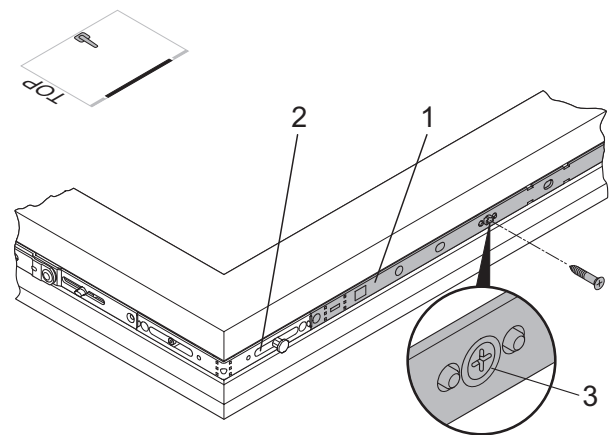

Interlocking rod M/MK (hinge side)

13



Please note! Damage to fittings. If the central fastening is not released, the locking device cannot be actuated. Use of force will lead to torsion of the fittings. Always insert the screw fully up to the stop.

See figure: Corner drive E1

- Screw the corner drive (1) in place.



Note: the following step is not needed, if you do not fit centre locking to the top corner drive.

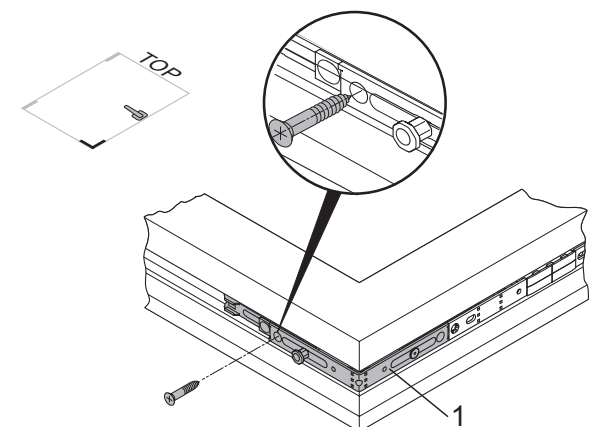

Corner drive E1

See figure: Interlocking rod M/MK (horizontal)

- Mount interlocking rod on the underside:
 - Fit the interlocking rod (2) flush against the corner drive (1)
 - Click the interlocking rod gears into the teeth of the corner drive.
 - Press the interlocking rod into the fitting groove.
 - Screw the interlocking rod from the corner drive to the centre of the window.
 - Tighten the screw (3) fully to release the central fastening.



Please note! Damage to fittings. If the central fastening is not released, the locking device cannot be actuated. Use of force will lead to torsion of the fittings. Always insert the screw fully up to the stop.

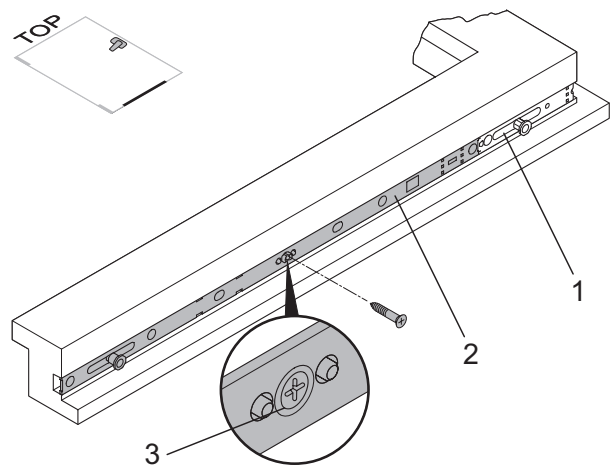

Interlocking rod M/MK (horizontal)

See figure: Sash Hinge FL.IF

- Fitting the sash hinge:
 - Insert the sash hinge (1) into the fitting groove on the bottom of the sash.
 - Make sure the sash hinge is fitted correctly into position.
 - Screw on sash hinge (1) tightly.



Note: If a turn limiter is to be connected to the sash hinge, the screw hole (2) must be exposed first.

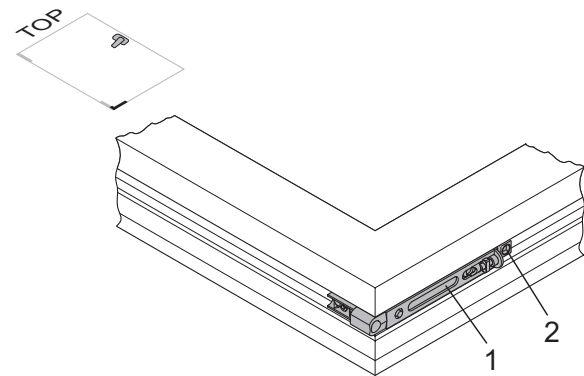

Sash Hinge FL.IF

See figure: Turn Limiter DB.IF

- Install turn limiter
 - Insert the turn limiter (2) into the fitting groove and connect to the sash hinge (1).
 - Fasten the turn limiter (2) tightly to the sash hinge (1) with a screw.
 - Push the shear arm down so that the screw holes underneath are exposed.
 - Screw turn limiter (2) into place.



Note: The holder (3) must point downwards with the guide edge facing the sash overlap.

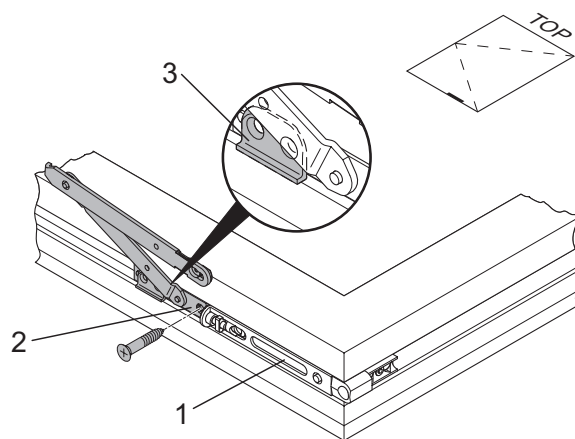

Turn Limiter DB.IF

Using the turn limiter is imperative if:

- Reveal depth of surrounding masonry < 120 mm (DIN EN 13126-8, Point 4)



Note: A turn limiter should optionally be used on elements that are used as a doorway.



Please note! Check if all screws are fixed into place on the fitting parts.

Mounting of fittings on sash

Turn double sash type – Rectangular window



Note: The following figures refer to a window for left hand use. When fitting a window for right-hand use, the figures will be mirror-inverted.

See figure: Corner drive E1

- Mounting of interlocking rods:
 - Fit the corner drive (2) into the fitting groove at the top of the sash so that the octagonal bolt is on the top side.
 - Fit the corner drive (1) into the fitting groove at the bottom of the sash so that the octagonal bolt is on the underside
 - Fix both corner drives (1, 2) on the drive side with a single screw each.
 - Measure the sash rebate height (FFH).

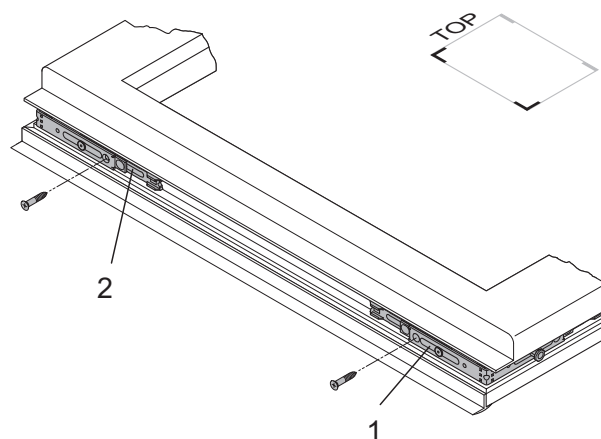

Corner drives E1

- Shorten the drive rod:
 - Shorten drive rod GASM or drive rod GASK in line with description "Shortening the fittings".



Note: Make sure you shorten the drive rod in closed state (as delivered).

See figure: Drive rod GASM/GASK

- Mount the drive rod:
 - Abut the drive rod (2) flush against the corner drive (3).
 - Allow the teeth on the drive rod to click into position on the gear rack on the corner drive.
 - Clip the drive rod into the corner drive (1) in the same way.
 - Press the drive rod into the eurogroove.
 - Screw the drive rod from the bottom up.



Note: to keep a neutral position, do not perform a function test until all fittings are in place.

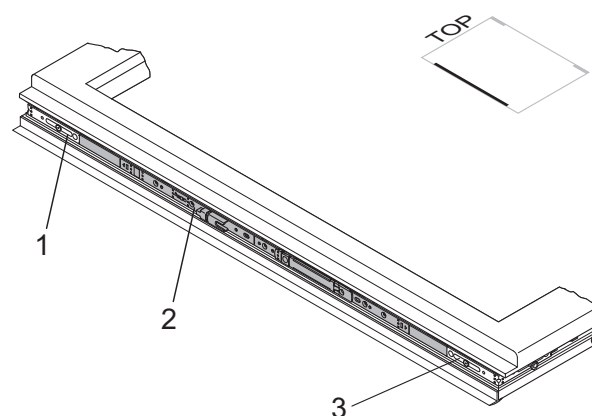

Drive rod GASM/GASK

See figure: Turn hinge rail DLS.IF

- Install turn hinge rail:
- Insert turn hinge rail (1) into the fitting groove on the top of the sash.
- Make sure the turn hinge rail is fitted correctly into position on the hinge side.
- Screw top hinge rail tightly onto the sash.

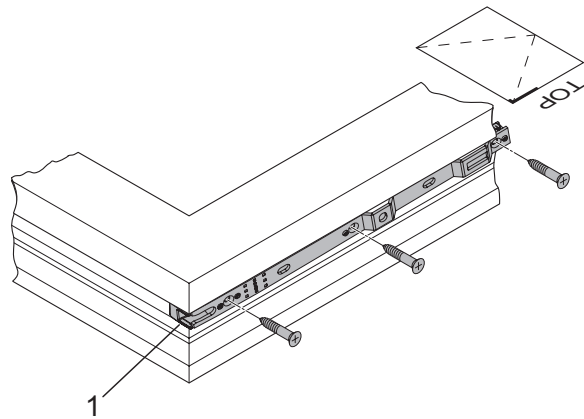

Turn hinge rail DLS.IF

See figure: Interlocking rod M (top)

- Mount the interlocking rod on the top side:
- Fit the interlocking rod (1) flush against the corner drive (2)
- Click the interlocking rod gears into the teeth of the corner drive.
- Press the interlocking rod into the fitting groove.
- Screw the interlocking rod tight from the hinge side to the gear side.
- Tighten the screw (3) fully to release the central fastening.

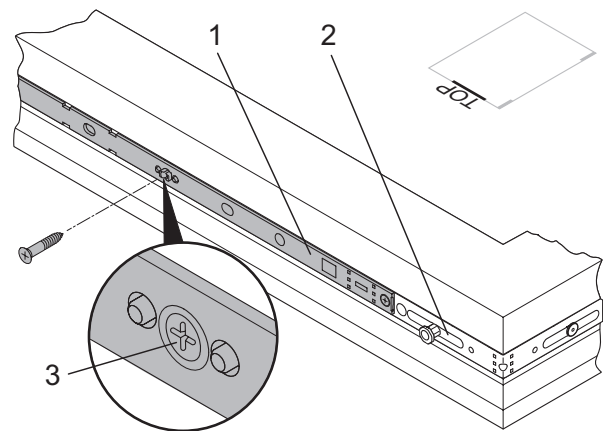

Interlocking rod M (top)



Please note! Damage to fittings. If the central fastening is not released, the locking device cannot be actuated. Use of force will lead to torsion of the fittings. Always insert the screw fully up to the stop.

See figure: Interlocking rod M (bottom)

- Mount interlocking rod on the underside:
- See above

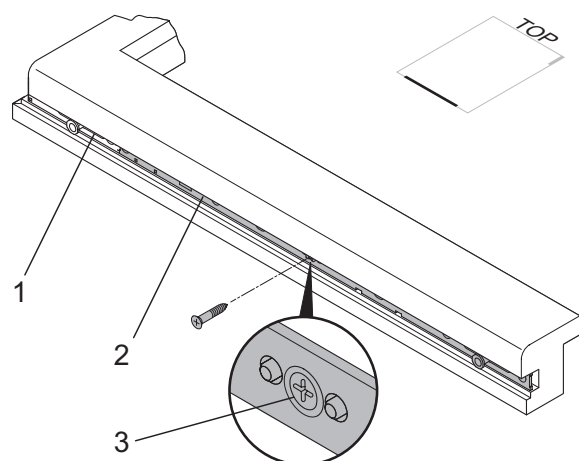

Interlocking rod M (bottom)

See figure: Claw bolt ZV-FT (hinge side)

- Position the claw bolt (1):
 - S (ZV-FT) = sash rebate edge to centre of keep ZV-FT
 - Press the claw bolt into the eurogroove and screw in place.

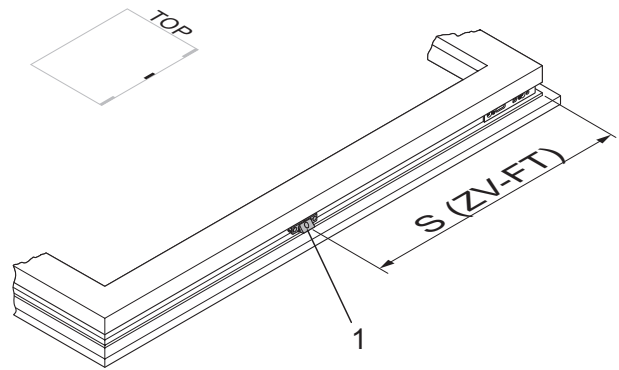

Claw bolt ZV-FT (hinge side)

See figure: Sash Hinge FL.IF

- Fitting the sash hinge:
 - Insert the sash hinge (1) into the fitting groove on the bottom of the sash.
 - Make sure the sash hinge is fitted correctly into position.
 - Screw the sash hinge (1) in place (start at hinge side).



Note: If a turn limiter is to be connected to the sash hinge, the screw hole (2) must be exposed first.

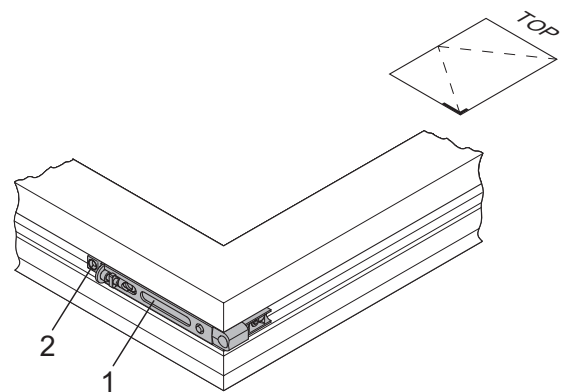

Sash Hinge FL.IF

13

See figure: Turn Limiter DB.IF

- Install turn limiter
 - Insert the turn limiter (2) into the fitting groove and connect to the sash hinge (1).
 - Fasten the turn limiter (2) tightly to the sash hinge (1) with a screw.
 - Push the shear arm down so that the screw holes underneath are exposed.
 - Screw turn limiter (2) into place.



Note: The holder (3) must point downwards with the guide edge facing the sash overlap.

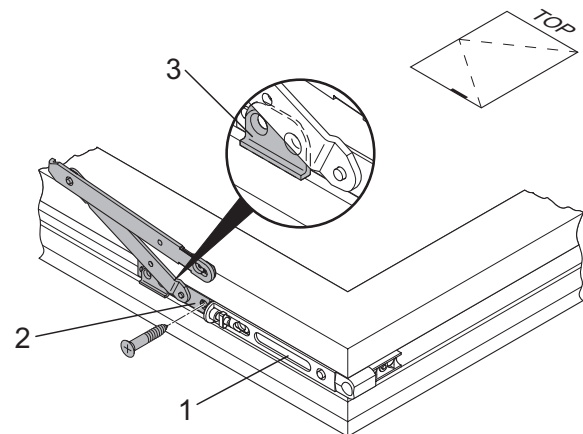

Turn Limiter DB.IF

Using the turn limiter is imperative if:

- Reveal depth of surrounding masonry < 120 mm (DIN EN 13126-8, Point 4)



Note: A turn limiter should optionally be used on elements that are used as a doorway.

Mounting of fittings on the window frame

Type: rectangular turn-tilt window

Keep positions

The following figures show the keep position options. The number of keeps depends on the size of the window. It is only possible to use frame parts which are suitable for the profile systems concerned and which have been approved by Winkhaus. The use of frame parts not developed especially for the frame profile concerned is not permitted and excludes us from any liability.



Note: The dimensions in the illustrations refer to the length from the frame rebate edge to the keep profile edge! A quick and simple assembly is made possible with the help of mounting jigs.

Fitting the keeps

Fitting jigs are positioned in the frame rebate.

In order to ensure the exact position, locking keeps must be placed prior to mounting corner and shear hinges. The fitting jigs are listed in the activPilot Concept catalogue.

Turn-tilt window GAK

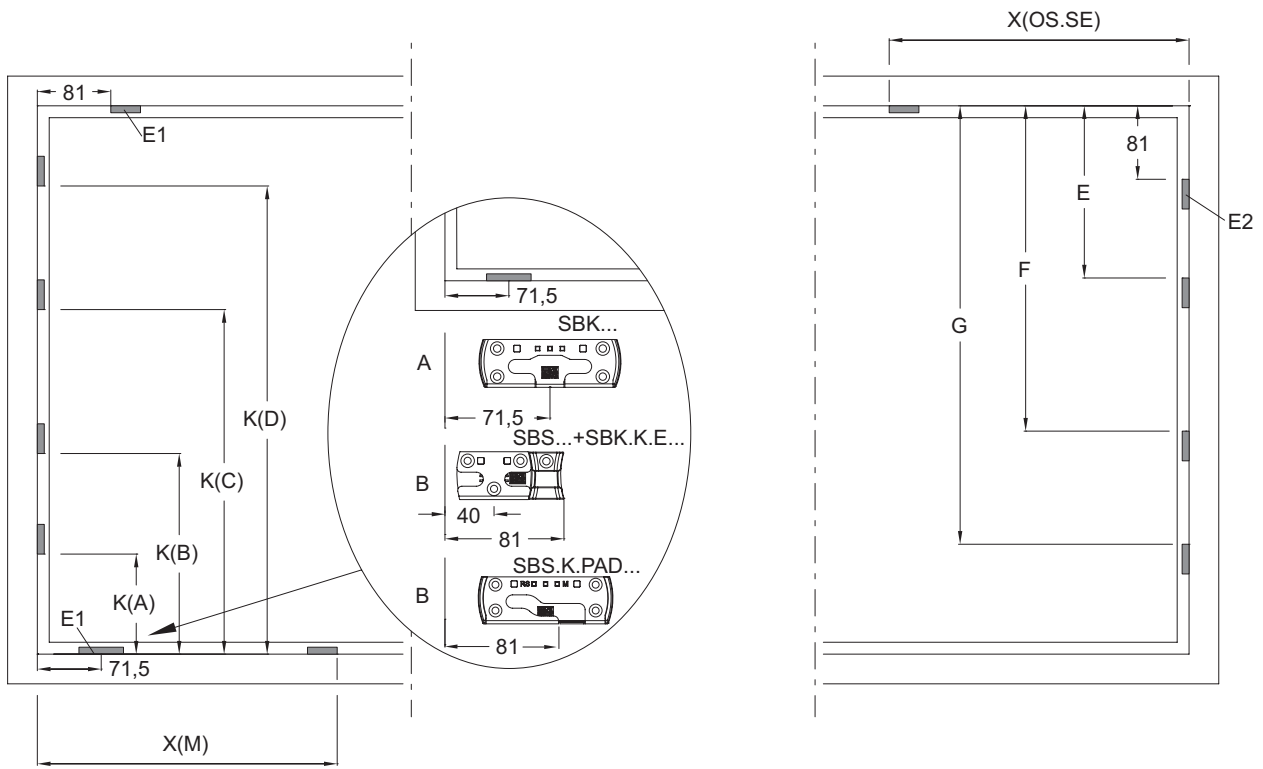

GAK...	K(A) [mm]	K(B) [mm]	K(C) [mm]	K(D) [mm]
GAK.830-1	385	-	-	-
GAK.945-1	385	-	-	-
GAK.1100-1	500	-	-	-
GAK.1195-1	750	-	-	-
GAK.1195-2	250	750	-	-
GAK.1325-1	750	-	-	-
GAK.1325-2	385	750	-	-
GAK.1550-1	750	-	-	-
GAK.1550-2	385	1000	-	-
GAK.1775-2	750	1250	-	-
GAK.1775-3	385	750	1250	-
GAK.2000-2	750	1250	-	-
GAK.2000-4	385	750	1250	1500
GAK.2225-2	750	1500	-	-
GAK.2225-4	385	750	1250	1750
GAK.2450-4	385	750	1250	1900

M...	X(M) [mm]
M.250-1	230
M.500-1	480
M.750-1	730

OS.SE...	X(OS.SE) [mm]
OS.SE.1025-1 / OS.SE.1025-1.E	480
OS.SE.1250-1 / OS.SE.1250-1.E	730

M...	E [mm]	F [mm]	G [mm]
M.250-1	250	-	-
M.500-1	500	-	-
	750	-	-
MK.250-1 + M.250-1	250	500	-
MK.500-1 + M.500-1	500	1000	-
MK.750-1 + M.500-1	750	1250	-
MK.750-1 + M.750-1	750	1500	-
MB.1000-2	500	1000	-
MB.1250-2	750	1250	-
MB.1450-2	750	1450	-
MB.1750-3	750	1250	1750

i In case of heavy sash weights and / or unfavourable shapes of the sash (FFB > FFH) we recommend you to use support keeps.

The illustration GAM.../GAK... shows the keep positions for backsets D15.5, D7.5 and D25-50. These positions also apply to GAMA/GAKA drive rods.

A = Standard operating sequence turn-tilt (OS.SE...)

B = Operating sequence Tilt-before-Turn (OS.SE...E)

Turn-tilt window GAM

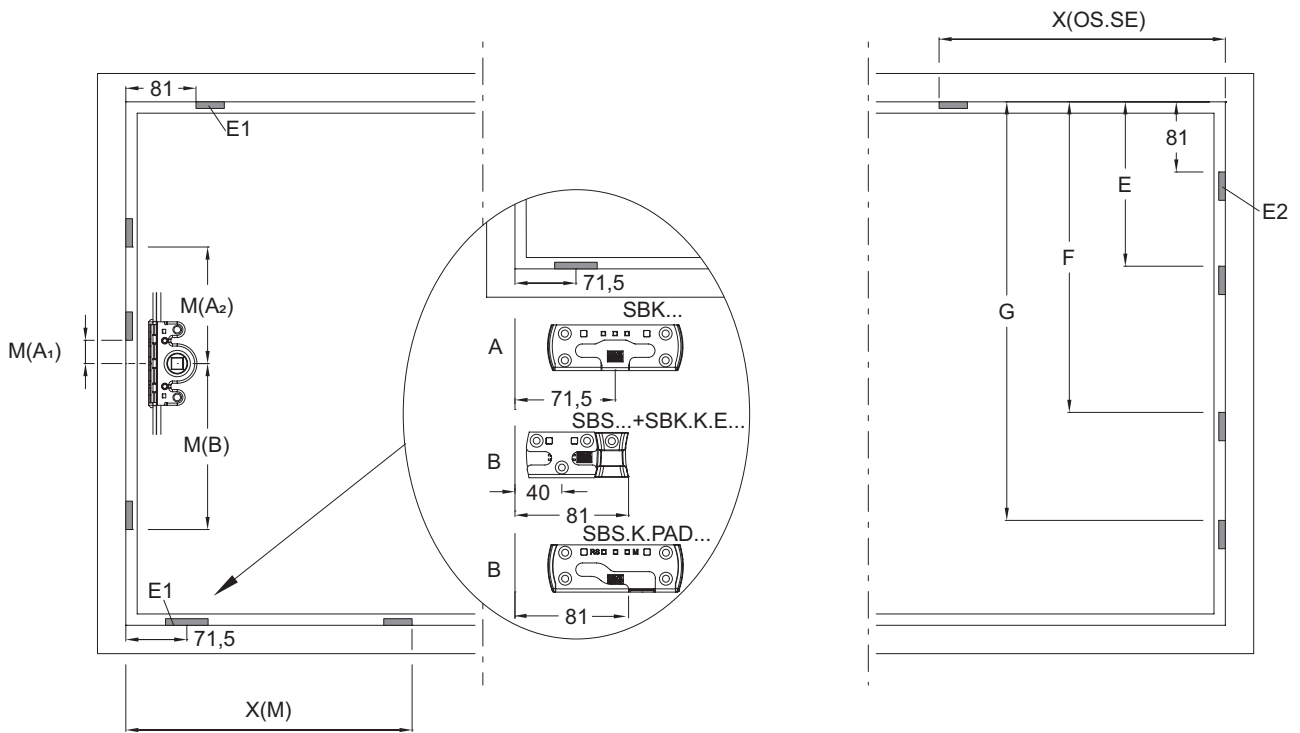

GAM...	M(A ₁) [mm]	M(A ₂) [mm]	M(B) [mm]
GAM.1050-1	127	-	-
GAM.1400-1	127	-	-
GAM.1400-2	127	-	223
GAM.1800-2	-	260	340
GAM.2300-3	127	692	520

M...	X(M) [mm]
M.250-1	230
M.500-1	480
M.750-1	730

OS.SE....	X(OS.SE) [mm]
OS.SE.1025-1 / OS.SE.1025-1.E	480
OS.SE.1250-1 / OS.SE.1250-1.E	730

M...	E [mm]	F [mm]	G [mm]
M.250-1	250	-	-
M.500-1	500	-	-
M.750-1	750	-	-
MK.250-1 + M.250-1	250	500	-
MK.500-1 + M.500-1	500	1000	-
MK.750-1 + M.500-1	750	1250	-
MK.750-1 + M.750-1	750	1500	-
MB.1000-2	500	1000	-
MB.1250-2	750	1250	-
MB.1450-2	750	1450	-
MB.1750-3	750	1250	1750

i In case of heavy sash weights and / or unfavourable shapes of the sash (FFB > FFH) we recommend you to use support keeps.

The illustration GAM.../GAK... shows the keep positions for backsets D15.5, D7.5 and D25-50. These positions also apply to GAMA/GAKA drive rods.
 A = Standard operating sequence turn-tilt (OS.SE...)
 B = Operating sequence Tilt-before-Turn (OS.SE...E)

Double-sash windows turn/turn-tilt

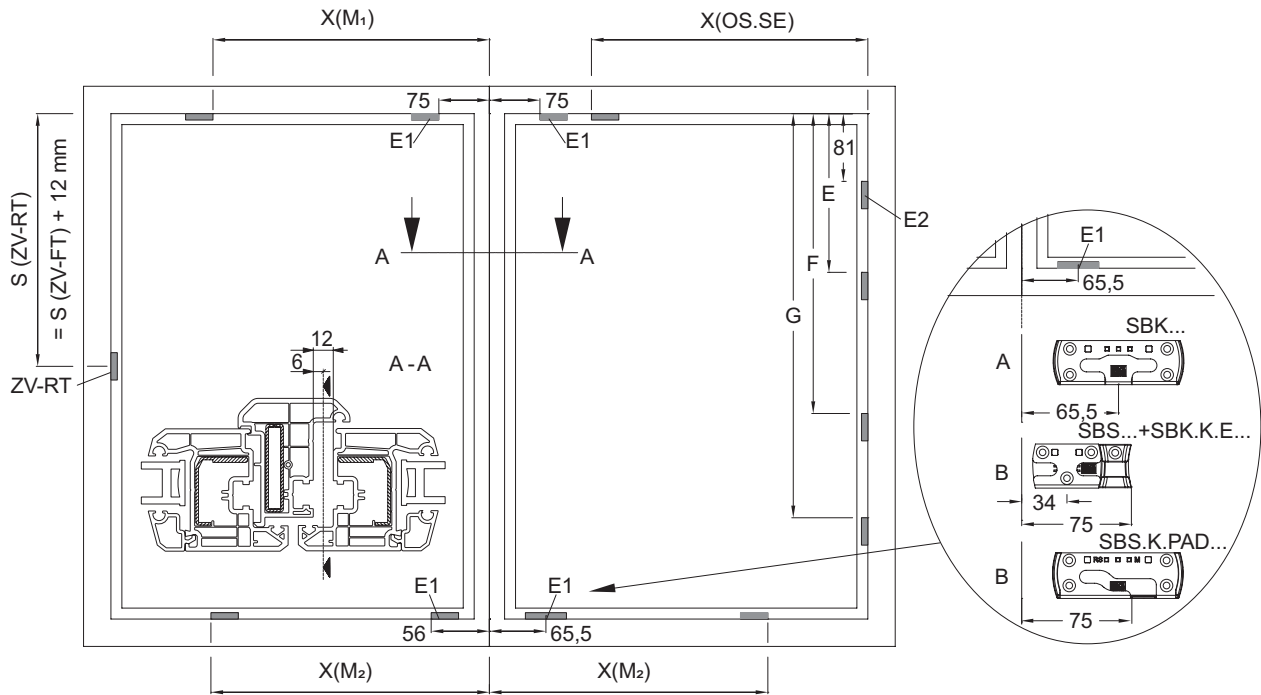

M...	X(M ₁) [mm]
M.250-1	244
M.500-1	494
M.750-1	744

M...	X(M ₂) [mm]
M.250-1	224
M.500-1	474
M.750-1	724

OS.SE...	X(OS.SE) [mm]
OS.SE.1025-1 / OS.SE.1025-1.E	480
OS.SE.1250-1 / OS.SE.1250-1.E	730

M...	E [mm]	F [mm]	G [mm]
M.250-1	250	-	-
M.500-1	500	-	-
M.750-1	750	-	-
MK.250-1 + M.250-1	250	500	-
MK.500-1 + M.500-1	500	1000	-
MK.750-1 + M.500-1	750	1250	-
MK.750-1 + M.750-1	750	1500	-
MB.1000-2	500	1000	-
MB.1250-2	750	1250	-
MB.1450-2	750	1450	-
MB.1750-3	750	1250	1750







In case of heavy sash weights and / or unfavourable shapes of the sash (FFB > FFH) we recommend you to use support keeps.

- A = Standard operating sequence turn-tilt (OS.SE...)
- B = Operating sequence Tilt-before-Turn (OS.SE...E)
- S (ZV-FT) = sash rebate edge to centre of keep ZV-FT
- S (ZV-RT) = frame rebate edge to centre of claw bolt ZV-FT

Fitting the keeps

Handling of mounting jigs is explained by reference to the L.E.N.K. 710-1100 mounting jig in the following. Other mounting jigs are used in the same way. To position keeps, place the mounting jig on the frame rebate edge.

Labelling of mounting jigs

	Horizontal attachment = red element (for top rod and interlocking rod)
	Vertical attachment = yellow element (for drive rods and interlocking rods)
	Vertical / horizontal attachment = blue element (for corner drives)
	= Keep run-in

Keep top horizontal

- Align the mounting jig with the yellow element in the top corner.
- Place the SBA keep on the blue element labelled "E1" and "E2".

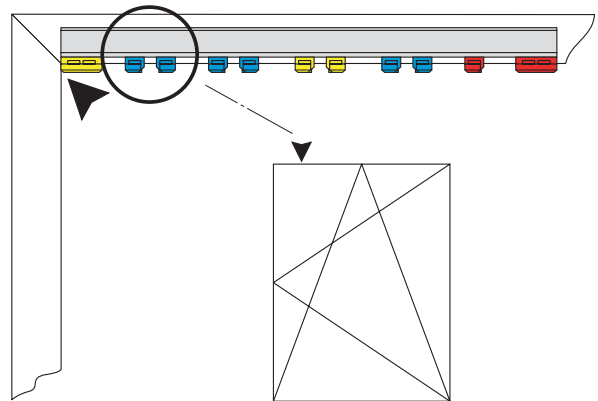

Keep top horizontal

Keep for top rod OS...

- Align the mounting jig with the red element in the top corner.
- Place the keep SBA on the blue element labelled "OS. ...".

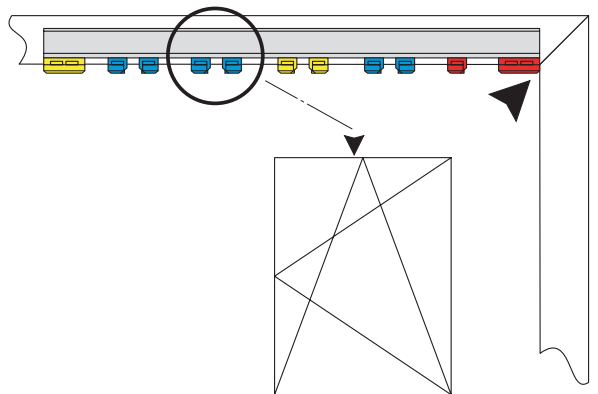

Keep for top rod OS...

Keeps hinge side

- Align the mounting jig with the yellow element in the top corner.
- Position the keep for the corner drive on the blue element.
- Position the keep for interlocking rod on the yellow element.



Note: The markings on the interlocking rod must match the marking on the yellow element.

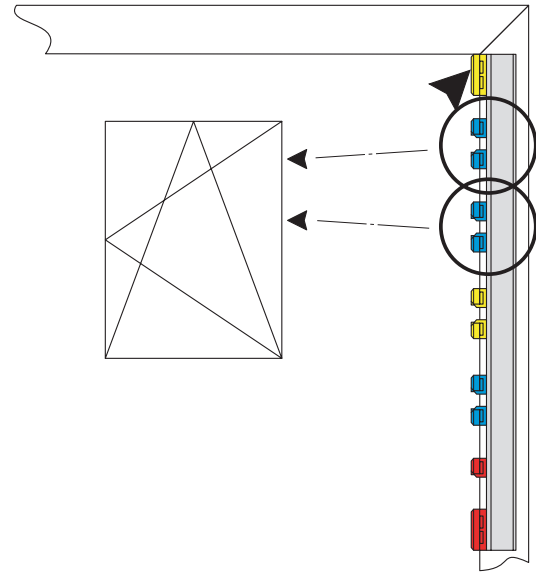

Keeps hinge side

Tilt keep SBK... bottom horizontal

- Align the mounting jig with the red element in the lower corner.
- Place the SBK... keep on the red element marked "Kippblech SBK".

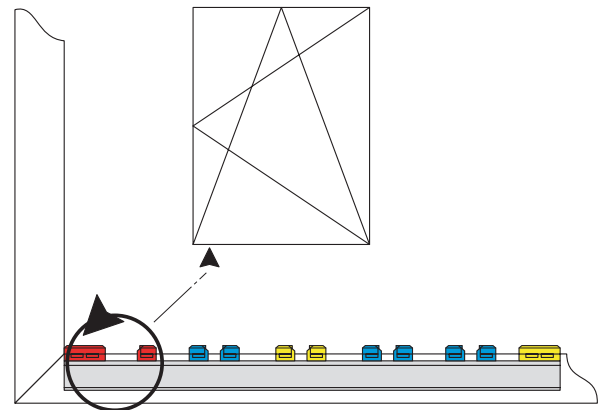

Tilt keep SBK... bottom horizontal

Interlocking Rod M..., bottom, horizontal

See figure: M bottom horizontal

- Align the mounting jig with the red element in the lower corner.
- Position the keep on the blue element marked "M" or "MK".

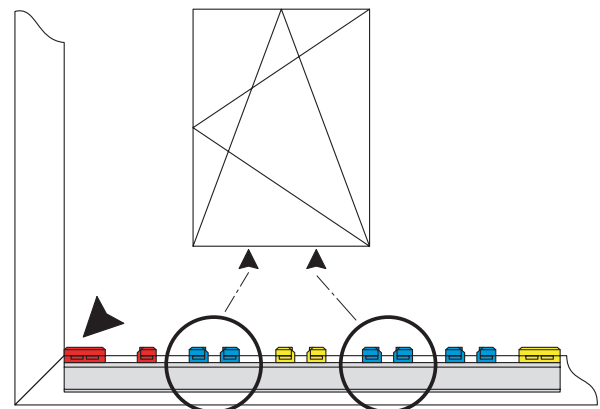

M bottom horizontal

Keeps SBA... for vertical GAK

- Align the mounting jig with the yellow element in the bottom corner.
- Place the SBA. ... keeps on the yellow and blue elements marked "GAK. ...".

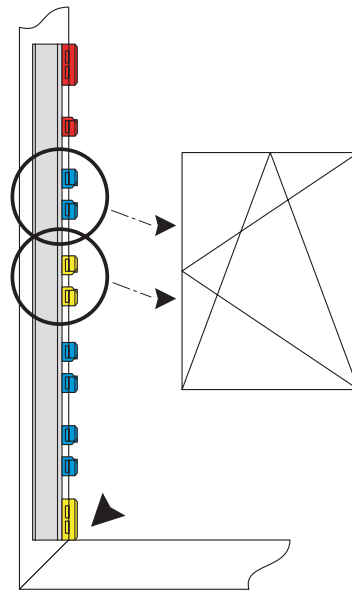

SBA... for vertical GAK

Keeps for GAM

- Attach the corresponding mounting jig labelled "top" or "bottom".
- Fit keeps in line with the labelling on the mounting template.

There are three telescopic jigs depending on the window height:

- LE.N.T. 0710-1050 for drive rod GAM 1050-1
- LE.N.T. 1051-1800 for drive rod GAM 1400-1/2 / 1800-2
- LE.N.T. 1801-2300 for drive rod GAM 2300-3



Note: The labelling on the drive rod must match the labelling on the yellow templates.

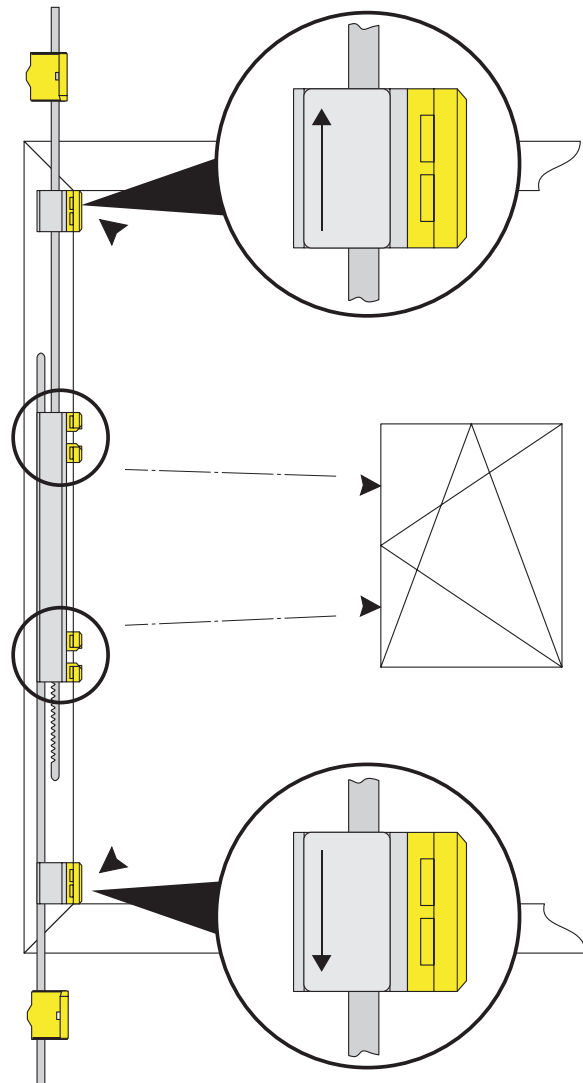

Keeps for GAM

Mounting of fittings on the window frame



It is only possible to use frame parts which are suitable for the profile systems concerned and which have been approved by Winkhaus. The use of frame parts not developed especially for the frame profile concerned is not permitted and excludes us from any liability. Please read the notes on the maximum sash weight in Group 1 (General Product Information).



Important: The screw connections of the load-bearing fitting components, such as corner, shear and sash hinges must be performed according to the TBDK guidelines. Adapt the drilling diameter for the fixing screws, the screw diameter and the screw length to the load situation.



Note: A detailed depiction of drill and screw positions can be found in chapter 15, installation drawings.

See figure: Corner Hinge EL...IF

- Mounting the corner hinge
 - Insert the corner hinge (1) into the frame profile.
 - Make sure the corner hinge is fitted correctly into position.
 - Drill screw holes and use suitable screws.
 - Screw corner hinge fully into position.

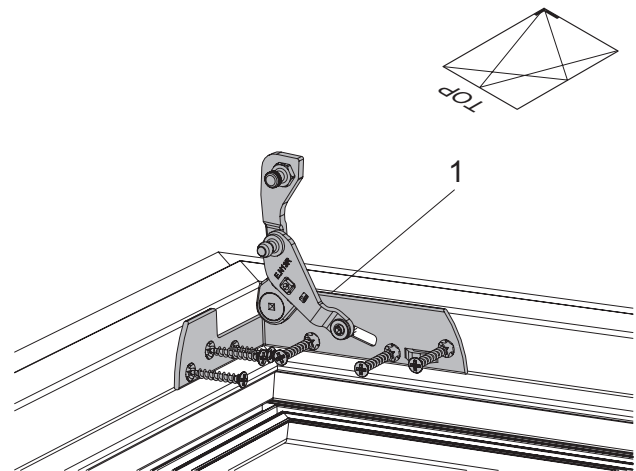

Corner Hinge EL...IF

See figure: Shear SH...IF

- Mounting the shear:
 - Insert the shear (1) into the frame profile.
 - Make sure the shear is fitted correctly into position.
 - Drill screw holes and use suitable screws.
 - Screw shear fully into position.

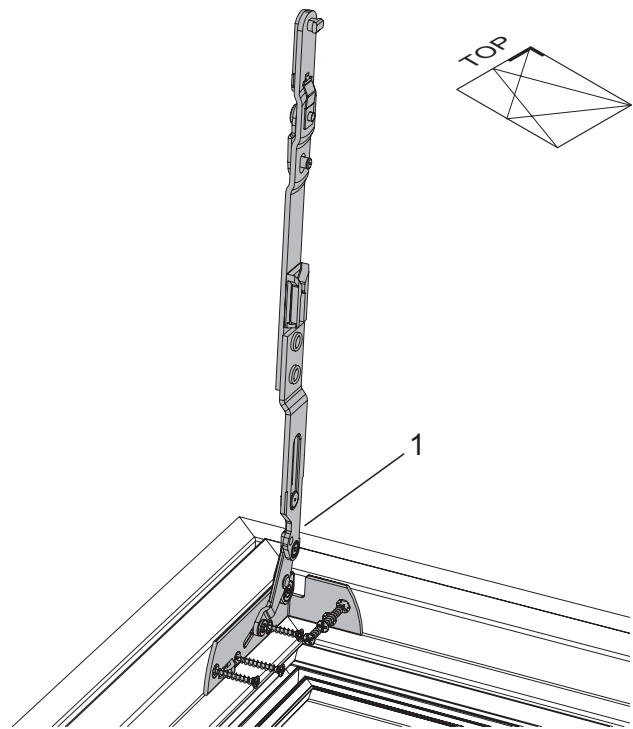

Shear SH...IF

See figure: Frame connection RA.DB...IF

- Insert the frame connection (1) into the frame profile and push against the corner hinge.
- Make sure the frame connection is positively locked.
- Drill screw holes and use suitable screws.
- Screw frame connection into place.



Only mount the frame connection if the turn limiter is used.

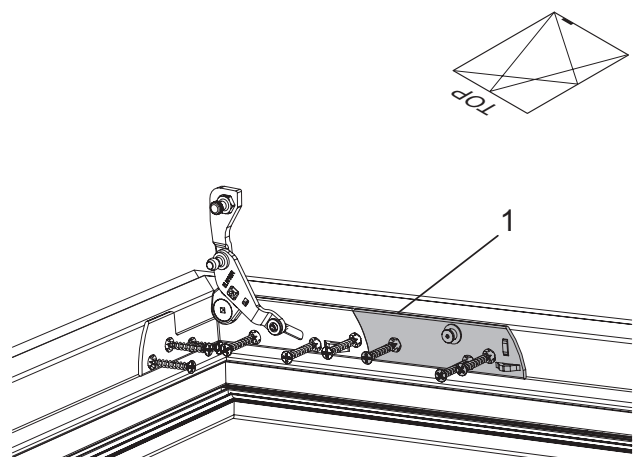

Frame connection RA.DB...IF

Fitting the sash

Installing sash at the bottom

See figure: Corner and Sash Hinges

- Adjust the fitting to "Turn" position.
- (If there is a fail-safe device, disconnect it.)
- Adjust the corner hinge brackets (1) to the "closed" position.
- Pivot the mount securing device (see figure "Installing the sash at the top"; position 1) 90° outwards and pivot the shear into the frame rebate.
- Lower the sash in a slightly tilted position to the brackets (1).
- Insert bolt (2) in the sash hinge top hinge point while inserting the bolt (3) in the sash hinge groove at the same time.

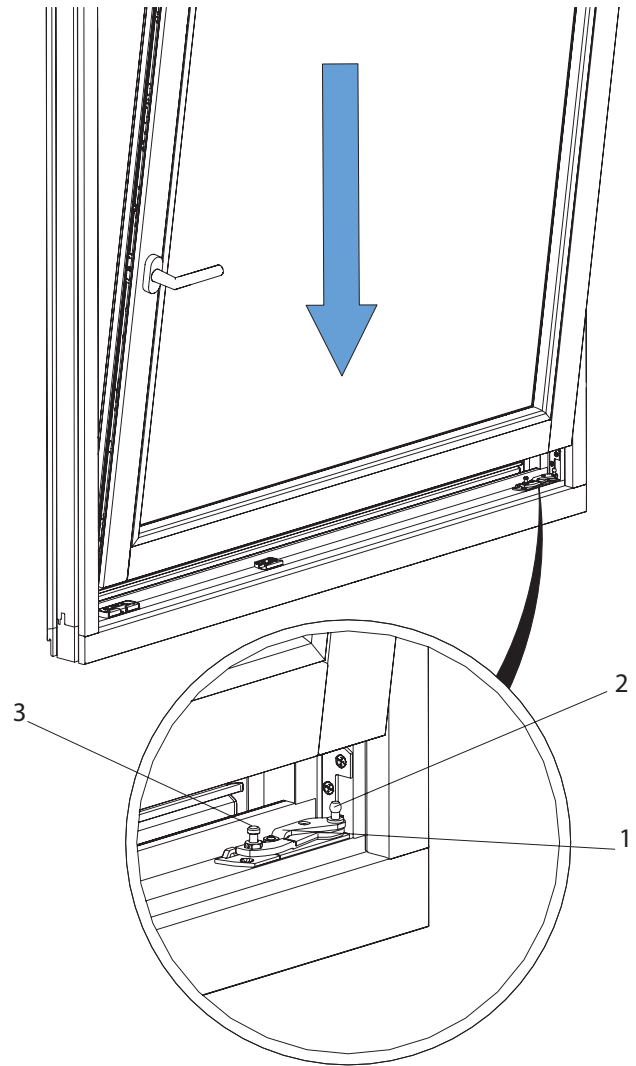

Corner and Sash Hinges



Important: Secure the window sash against falling. Take the heavy sash weight into account! Two people should carry the sash if necessary.



If a turn limiter is used, it must be ensured that it is pivoted inward before the sash is attached. In doing so, damage to the window frame can be avoided!

Support the sash!



Open the sash to a 90° turn position and support!



Important: Secure the window sash against falling. Take the heavy sash weight into account! Two people should carry the sash if necessary.

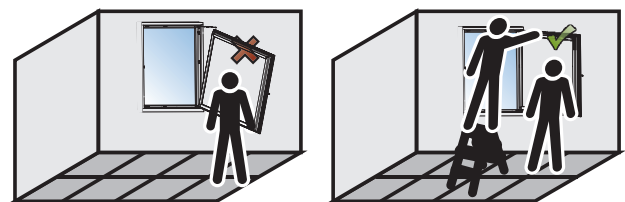

Support the sash!

Engaging the sash at the top

See figure: Engaging the sash at the top

- Open the sash (only surface-mounted on the bottom frame hinge) to a 90° turn position.
- (If there is a fail-safe device, disconnect it.)
- Turn the window handle to the tilt position.
- Open shear 90° and place over the retaining bolt (4) on the top rod.
- Press in the shear bolt (3) into the opening in the counter bracket.
- Press the hammer head bolt into the elongated hole on the top rod. The shear arm should be flush with the top rod.
- Swivel the mount securing device (1) into position by hand, so that the stop spring (2) clicks into place.
- Set fitting to "Turn" position. Then check whether the shear is securely fastened to the top rod and the sash hinge to the corner hinge.



Please note! Risk of injury. The sash can fall out and cause injuries if the shear and top rod are not securely fastened. It is important to ensure the stop spring is firmly in position (clicking sound).



The mount securing device (1) must be pivoted by hand – without the use of tools, such as a hammer, screwdriver, etc. – such that the safety spring (2) detents.

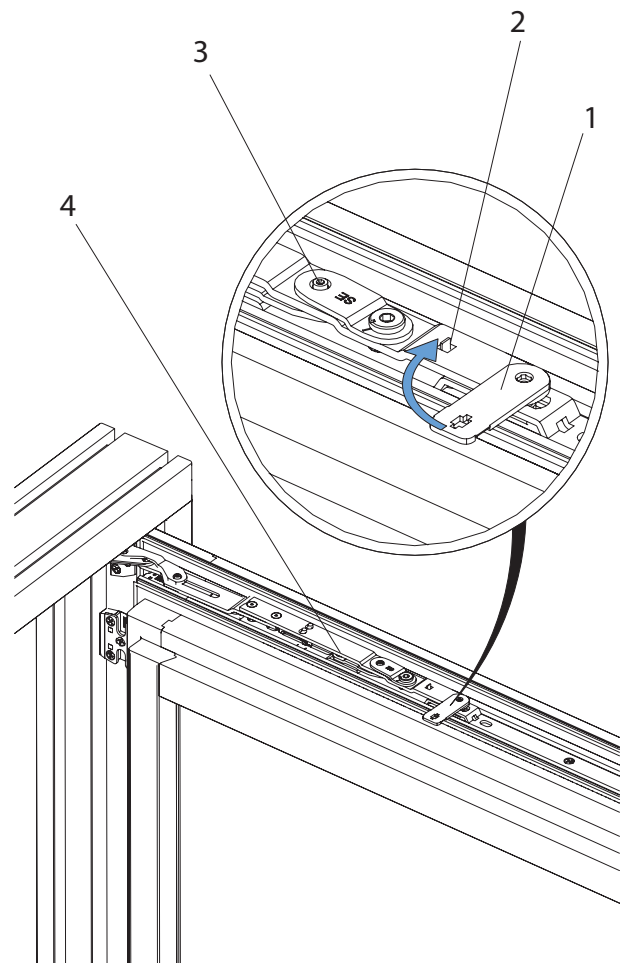

Engaging the sash at the top

Install turn limiter

See figure: Install turn limiter

- Place the turn limiter arm on the retainer pin, so that the stop spring clicks into place behind the retainer pin.
- It is important to ensure the stop spring is firmly in position (clicking sound).

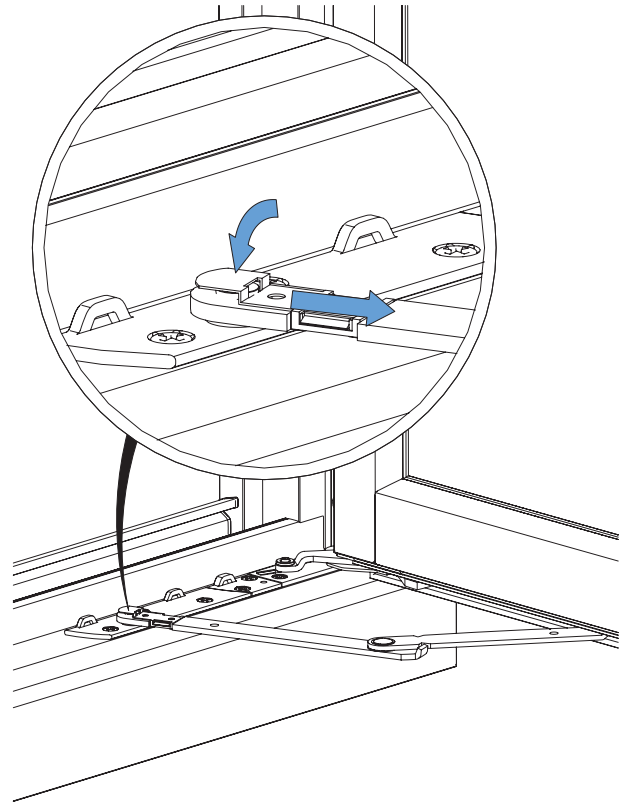

Install turn limiter

Removal of the sash

Detaching the turn limiter

See figure: Detaching the turn limiter

Preparation:

- Move the sash into the 90° turn position.
- Detaching the turn limiter

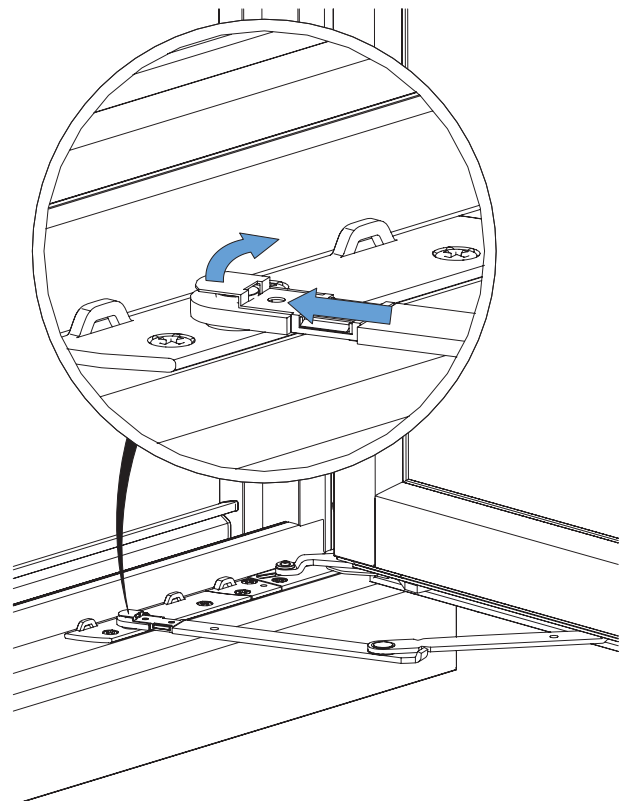

Detaching the turn limiter

Support the sash!

 Open the sash to a 90° turn position and support!

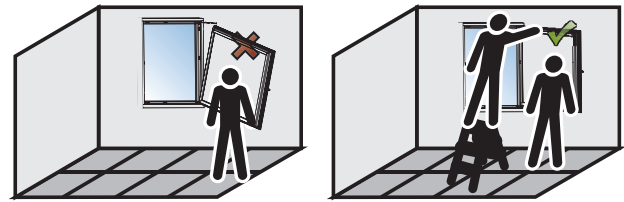

Support the sash!

Unlocking the mount securing device

See figure: Remove the sash

Unlocking the mount securing device (1) of the shear:

- Press down the stop spring (2) with a screwdriver while swivelling the mount securing device (1) outwards 90° at the same time.

 Important: Secure the window sash against falling. Take the heavy sash weight into account! Two people should carry the sash if necessary.

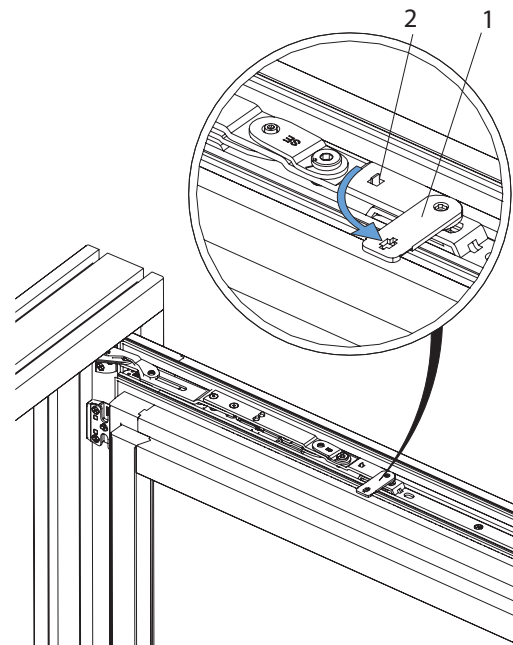

Lifting the sash out of the bottom frame hinge

See figure: Removing the sash

- Pivot the uncoupled shear arm into the frame rebate.
- Move the sash (only surface-mounted on the bottom frame hinge) to a nearly closed position.
- Tilt the sash slightly and lift it up out of the bottom frame hinge.

Remove the sash

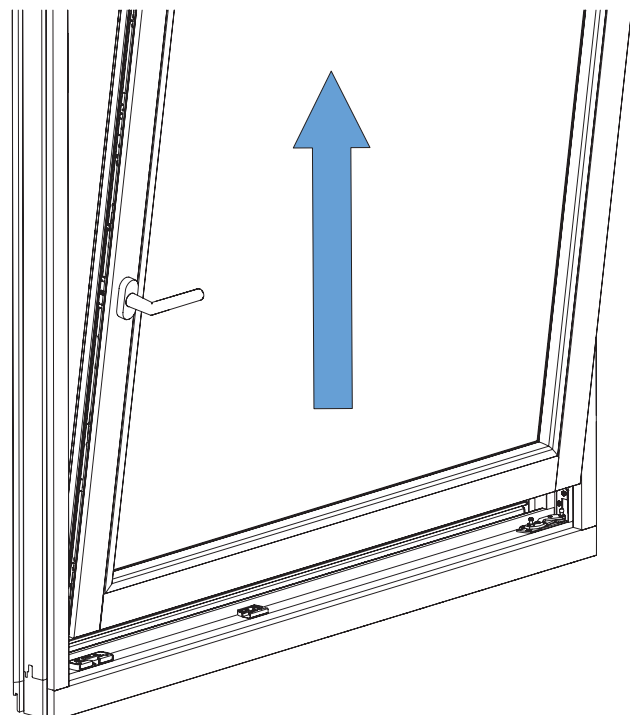

Lifting the sash out of the bottom frame hinge

Function test / Operation

Turn-tilt type

See figure: Function test turn-tilt window

- Place the handle and operate once as follows to release the central fastening.
- Push the handle down (c). The window is closed.
- Move the handle to the central position (a). The window is unlocked; the sash can now be opened fully.
- Close the sash. Push the handle up (b). The window is unlocked; the sash can now be tilted.

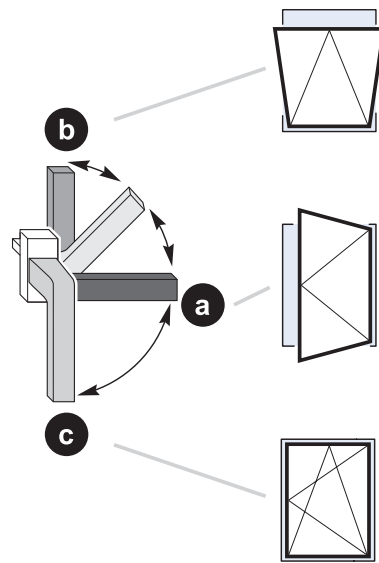

i Note: The handle will be stiffer than normal the first time it is used. A clicking noise will be heard during actuation. Keep the window closed during actuation.

Function test turn-tilt window

Turn double sash type

See figure: Function test turn double sash window

- Actuate the handle as follows to release the central fastening.
- Press the unlocking button (1) and press the lever down to its limit position.
- The window is unlocked; the sash can now be opened fully.

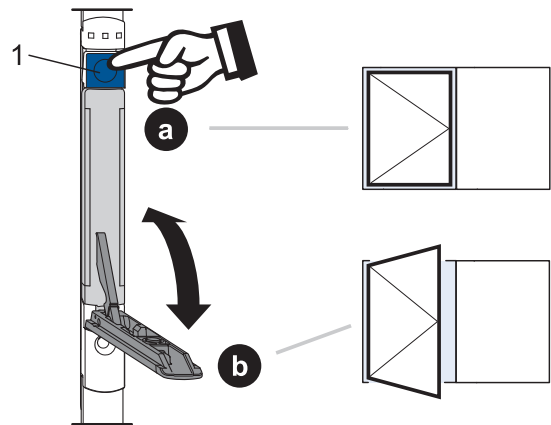

Function test turn double sash window

i Note: When you actuate the lever for the first time, the gearing is 'unblocked' and coupling to the connected fittings is established. The handle will be stiffer than normal the first time it is used. A cracking noise can be heard when switching. Keep the window closed during actuation.

Adjustment options

Octagonal bolt

Regulate the contact pressure between the sash and the frame (± 0.8 mm) by turning the octagonal bolt. The adjustment can be carried out by means of the Winkhaus adjustment key (V.ST.SCH.HV-11).

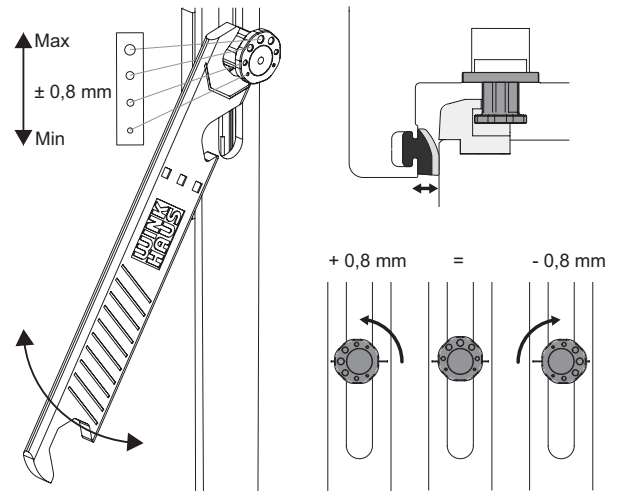

Octagonal bolt

Shears

The sash is raised and lowered by adjusting the shear slide-way. The sash can be raised 2.5 mm and lowered 1.5 mm.

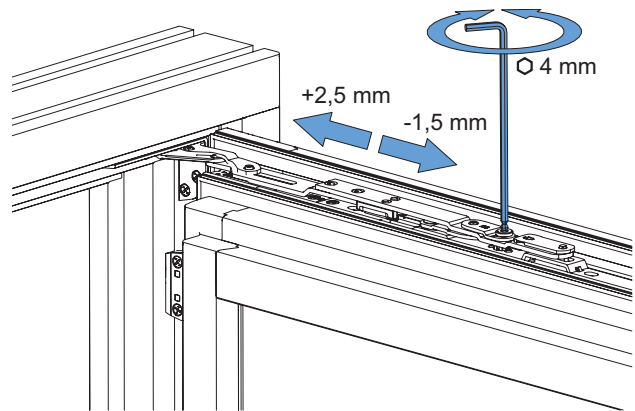

Shears

Adjustment options

Height and side adjustment

Corner and Sash Hinges

Adjustment tool: Allen key with ball head (size 4)

- Height adjustment +2 mm / -1.5 mm (1)
- Side adjustment +2.5 mm / -2.5 mm (2)

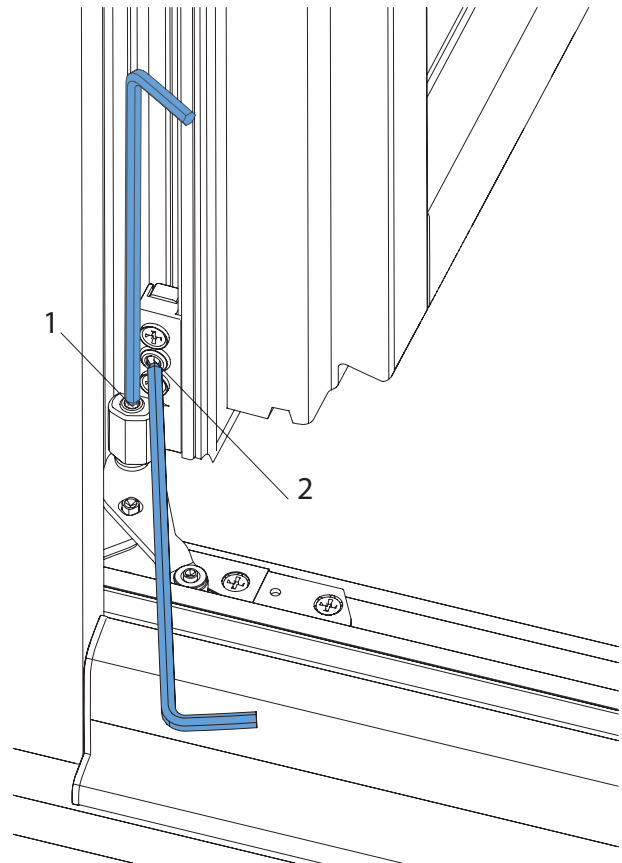

Height and side adjustment

Contact pressure adjustment

Sash hinges

Adjustment tool: Open-ended spanner (size 10)

- Pressure adjustment ± 0.8 mm

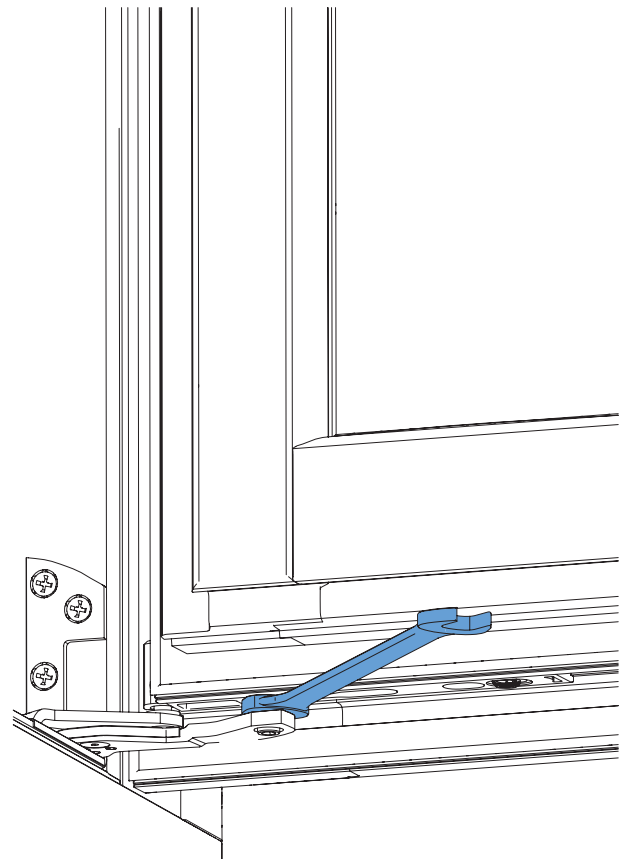

Contact pressure adjustment

Maintenance

Lubrication points

See figure: Overview of lubrication points

The figure shows the location of possible lubrication points which should be lubricated at least once a year.

Positions A, C, D = lubrication points relevant to function.

Position B = safety-relevant lubrication point

i Note: The fitting schematic shown adjacent does not necessarily match the existing fitting. The number of locking positions will vary depending on size and type of the window sash.

! Please note! Risk of injury. The window could fall on removal and thus injure persons. Do not remove the window for maintenance.

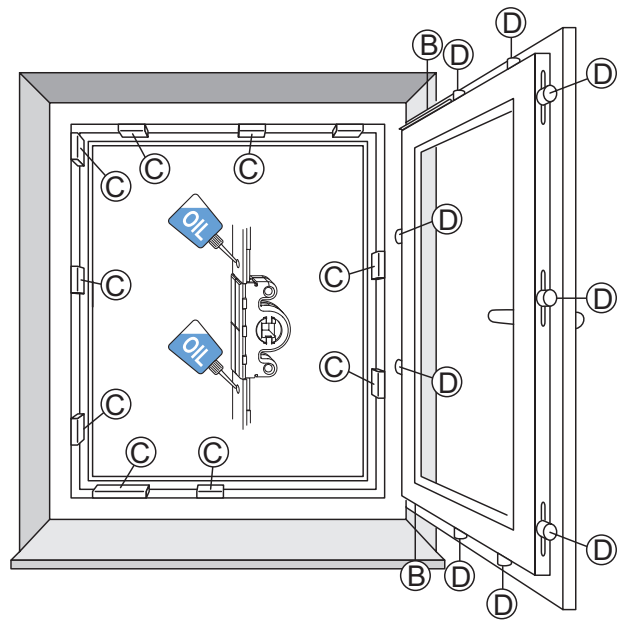

Overview of lubrication points

Locking keeps

See figure: Lubrication points

To keep fittings running smoothly, you must lubricate the keeps at least once a year.

- Lubricate the keeps (C) at the run-in side with technical Vaseline or any other suitable grease.
- Coat the running surfaces of the locking bolts (D) with an oil that is free of resins and acids.

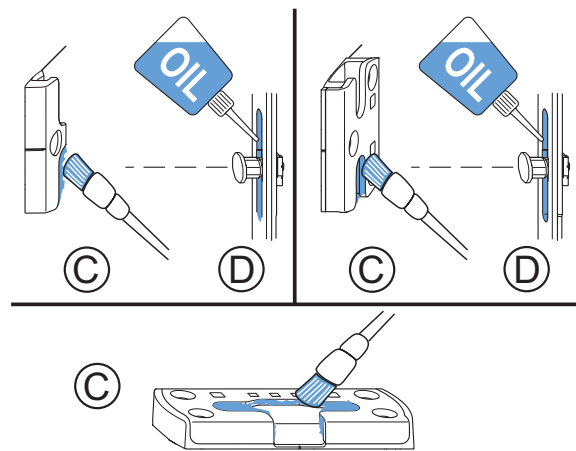

Lubrication points

Ascertaining the run-in sides

See figure: Run-in sides

- Left-handed window; handle right
- Right-handed window; handle left

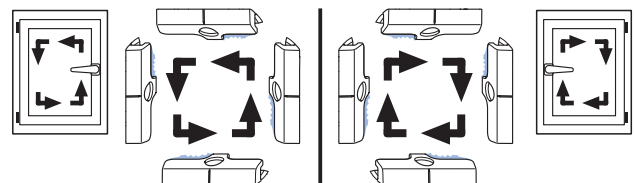

Run-in sides

Maintenance

Lubrication points

Shear and corner hinge

See figure: Shear and corner hinge

Fitting parts are to be tested regularly (at least once annually or semi-annually in schools and hotels) to ensure they are seated firmly and checked for wear. Fastening screws are to be retightened and parts replaced as necessary. Their functionality is to be retested afterwards. All moving contact points on the shear and the corner hinge should be greased with a suitable lubricant at least once a year. Coat lubricating points with non-resinous, non-corroding grease.

B

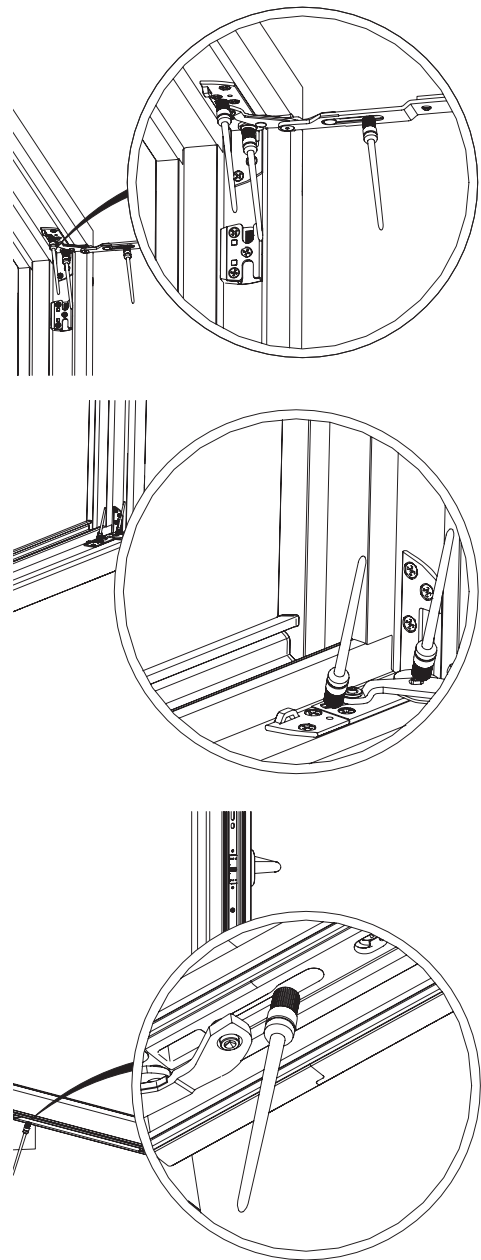
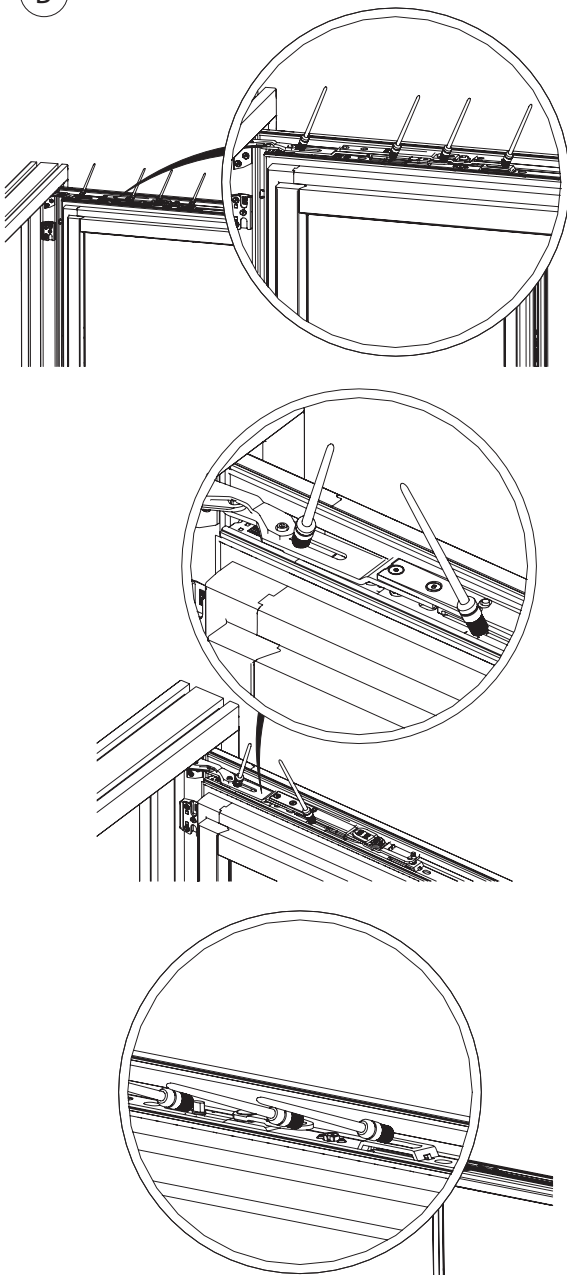

14



Please note! Risk of injury. The window could fall on removal and thus injure persons. Do not remove the window for maintenance.

Adjustment and maintenance

Dual/triple function element

DFE/TFE activation

The DFE/TFE element is supplied in the neutral position. Please proceed as follows: Drive in the protruding pin to fix in place (1). Can be used left/right by swivelling out the lever once only. Dribble a few drops of oil (free of resin and acid) onto lubrication points.

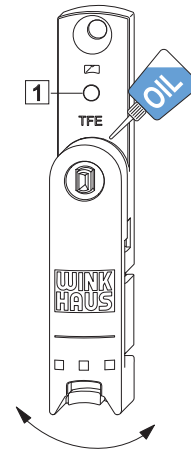

DFE/TFE activation

TFE – Retaining force of balcony door catch

Adjusting the holding force by re-setting the eccentric cam with a 4 mm Allen key. Dribble a few drops of oil (free of resin and acid) onto lubrication points.

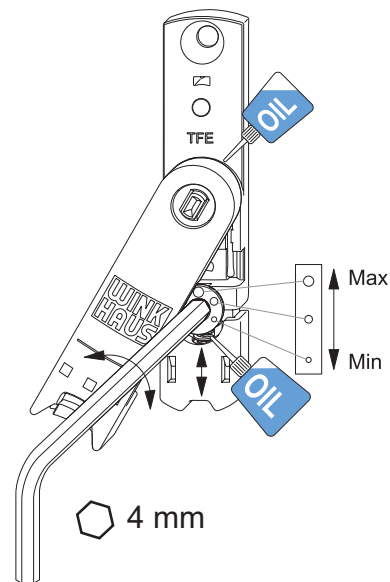

TFE - Retaining force of balcony door catch

Frame part DFE/TFE

Height adjustment (± 3 mm) for sash support plate. Each time fittings are adjusted, the DFE/TFE height setting should also be checked using a 2.5 mm Allen key.

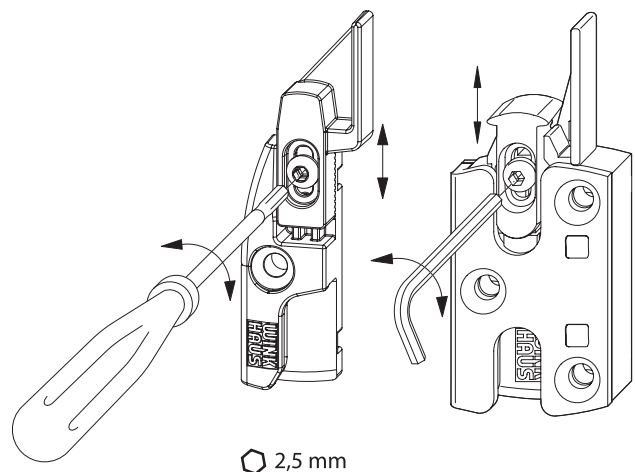

Frame part DFE/TFE

Installation drawings activPilot Topstar

Corner hinge/ shear/ frame connection

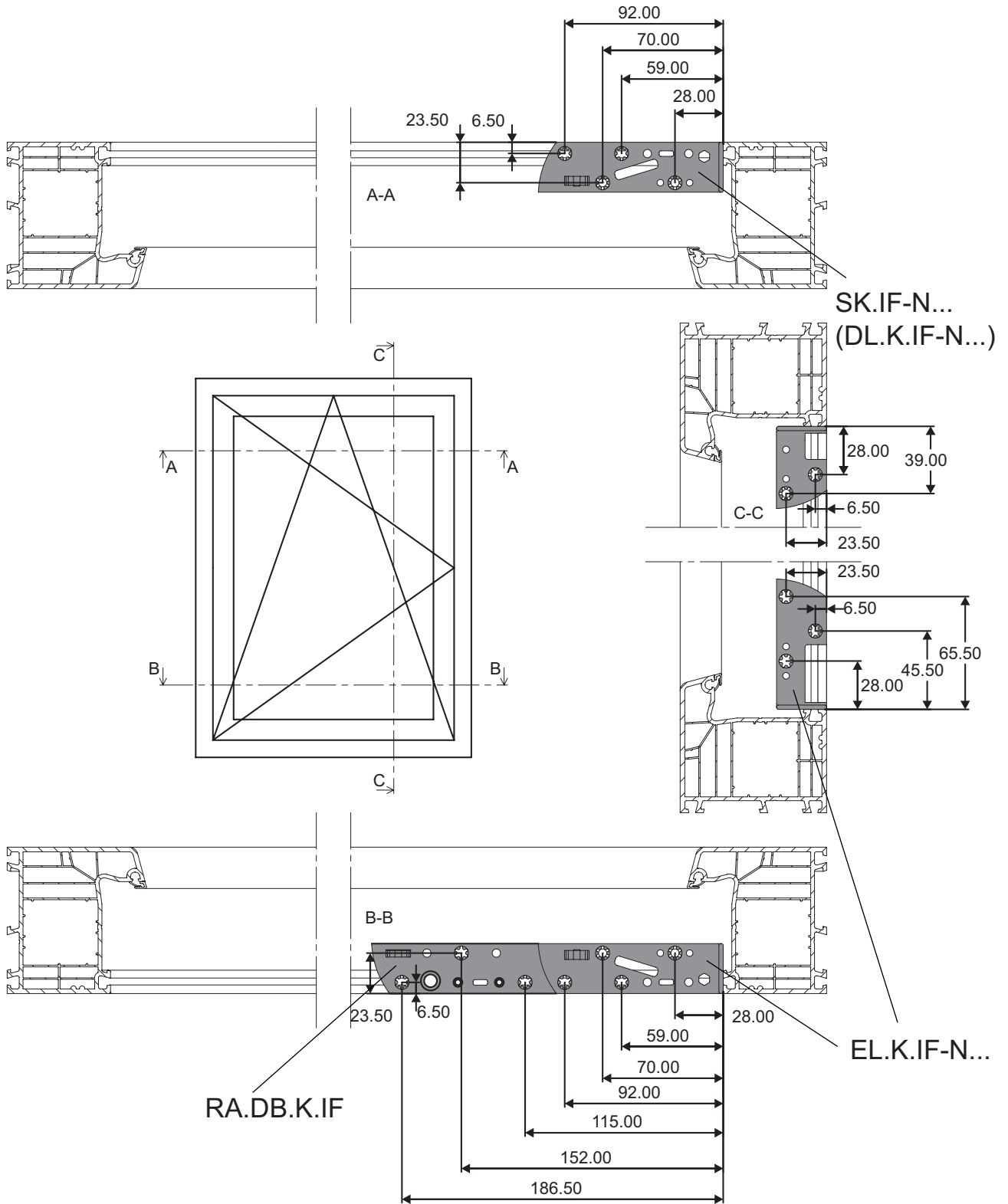

Installation drawings

activPilot Topstar 3-sash window units

Corner hinge/ shear/ turn hinge

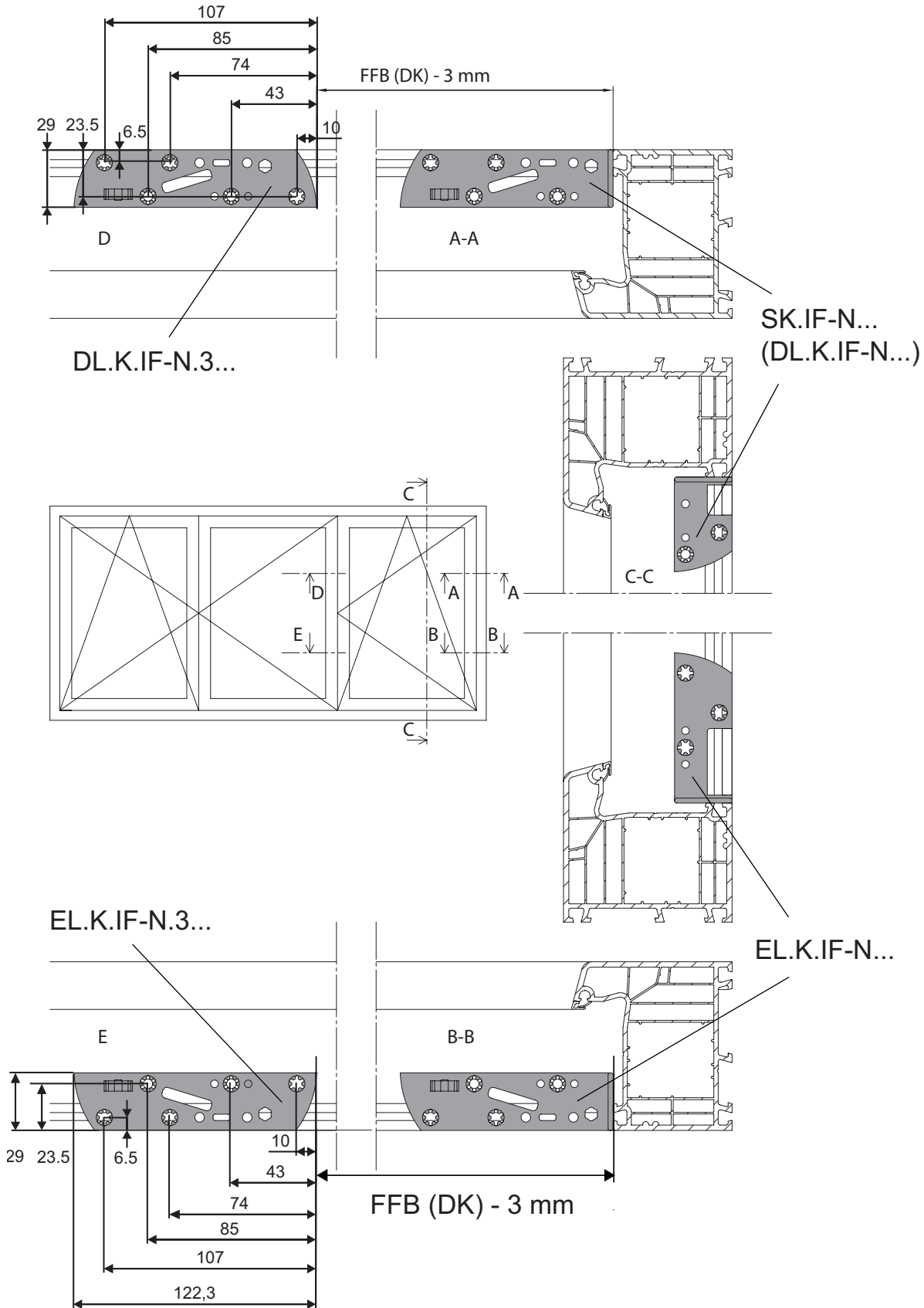

Aug. Winkhaus GmbH & Co. KG

August-Winkhaus-Straße 31

D-48291 Telgte

T +49 2504 921-0

F +49 2504 921-340

fenstertechnik@winkhaus.de

winkhaus.com